

# ZigBee & RF 5 in 1 LED Controller

- 5 in 1 function, used for control RGB, RGBW, RGB+CCT, color temperature or single color LED strip.
- DC power socket input and 5 channel constant voltage output.
- Tuya smart APP cloud control, support on/off, RGB color, color temperature and brightness adjust, delay turn on/off light, timer run, scene edit and music play function.
- Philips HUE APP control by connect with Philips HUE bridge.
- Voice control, support for Amazon Alexa, Google Assistant, Tmall Genie and Xiaodu voice assistant.
- Match with RF 2.4G remote control optional.
- User need set light type by press key before Tuya smart APP network connection and match RF remote of the same light type.
- Each WZ5 controller can also work as ZigBee-RF converter, then use Tuya smart APP to control one or more RF LED controller or RF LED dimming driver synchronously.
- Light on/off fade time 3s selectable.

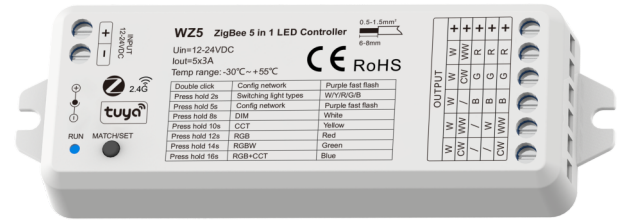

CE RoHS RED

## Technical Parameters

Input and Output		Dimming data		Safety and EMC	
Input voltage	12-24VDC	Input signal	Zigbee + RF 2.4GHz	EMC standard	EN 62479:2010 ETSI EN 301 489-1 V2.2.3 ETSI EN 301 489-17 V3.2.4
Input current	15.5A	Control distance	30m(Barrier-free space)	Safety standard	EN 61347-1:2015+A1:2021 EN 61347-2-13:2014+A1:2017
Output voltage	5 x (12-24)VDC	Dimming gray scale	4096 (2^12) levels	Radio Equipment	ETSI EN 300 328 V2.2.2
Output current	5CH,3A/CH	Dimming range	0 -100%	Certification	CE RED
Output power	5 x (36-72)W	Dimming curve	Logarithmic	<b>Warranty and Protection</b>	
Output type	Constant voltage	PWM frequency	1000Hz(default)	Warranty	5 years
<b>Environment</b>		<b>Package</b>		Protection	Reverse polarity Over-heat Short circuit
Operation temperature	Ta: -30°C ~ +55°C	Size	L120 x W43 x H27mm		
Case temperature (Max.)	Tc: +85°C	Gross weight	0.055kg		

## System wiring

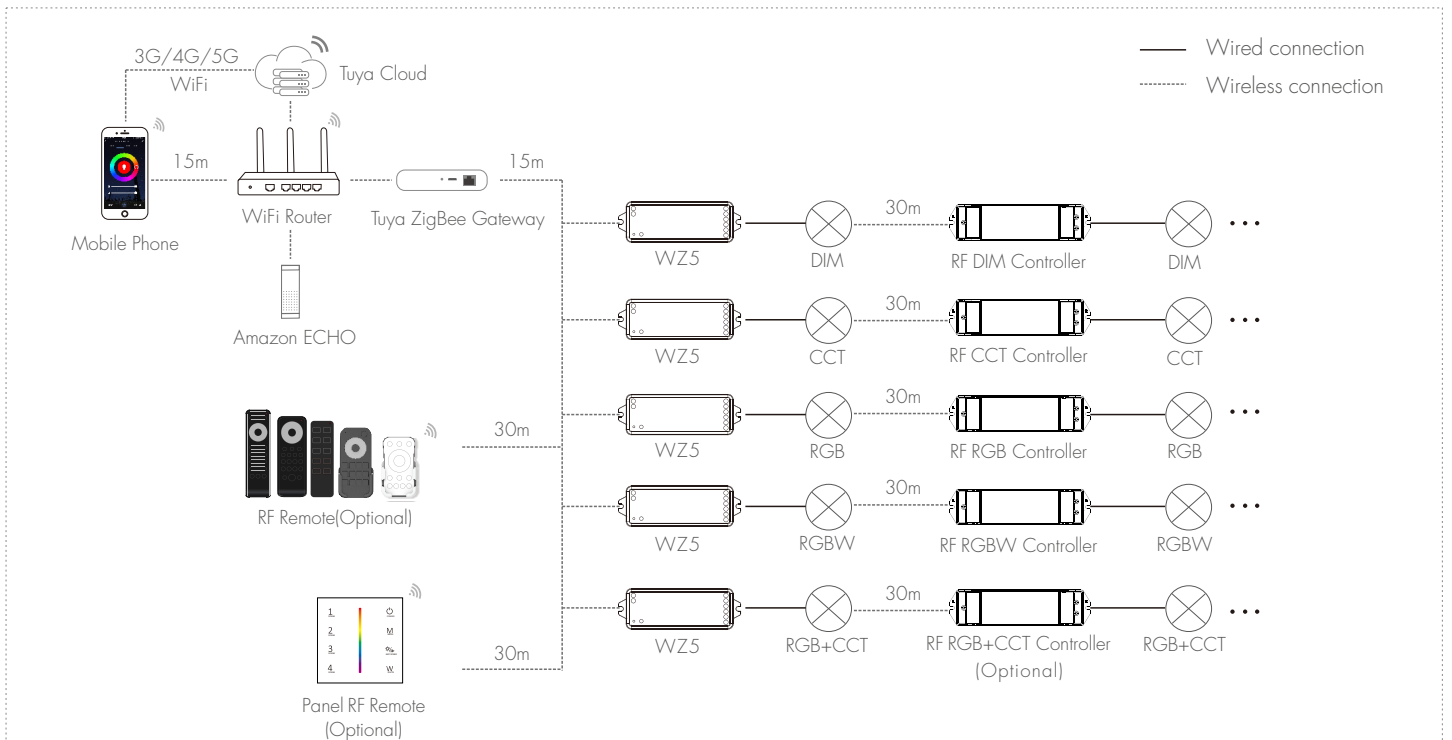

**Note:**

1. The above distance is measured in spacious (no obstacle) environment, please refer to the actual test distance before installation.
2. Users must use the Tuya ZigBee gateway to realize remote control and voice control.

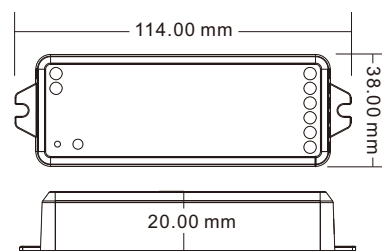
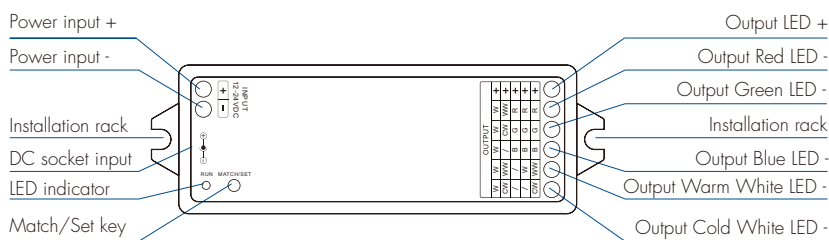

## Wiring Diagram

### • For RGB+CCT

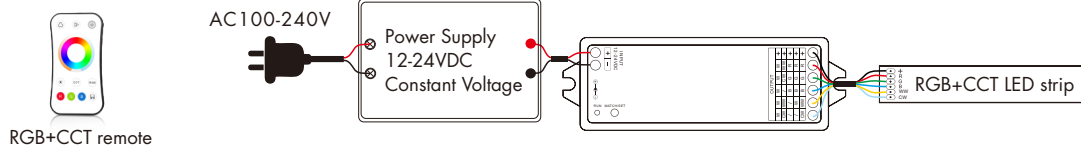

Press and hold match/set key for 16s, until the RUN LED indicator turn blue, then release, the controller will become RGB+CCT type, then do smart config by Tuya smart APP, or short press match key to match with RGB+CCT RF remote.

### • For RGBW

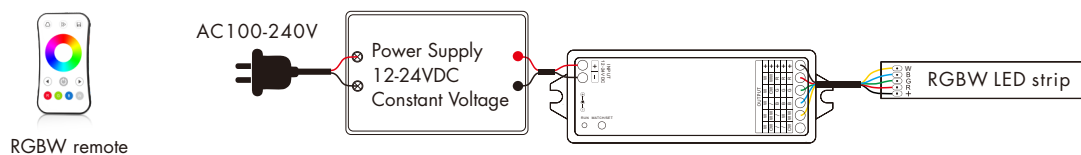

Press and hold match/set key for 14s, until the RUN LED indicator turn green, then release, the controller will become RGBW type, then do smart config by Tuya smart APP, or short press match key to match with RGBW RF remote.

### • For RGB

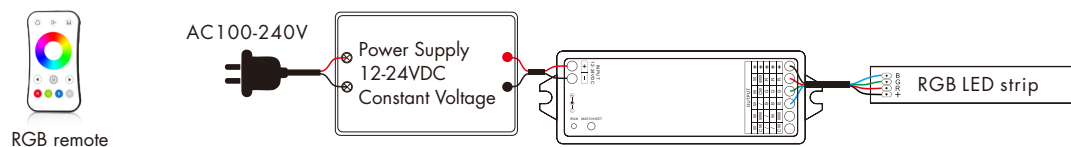

Press and hold match/set key for 12s, until the RUN LED indicator turn red, then release, the controller will become RGB type, then do smart config by Tuya smart APP, or short press match key to match with RGB RF remote.

### • For dual color CCT

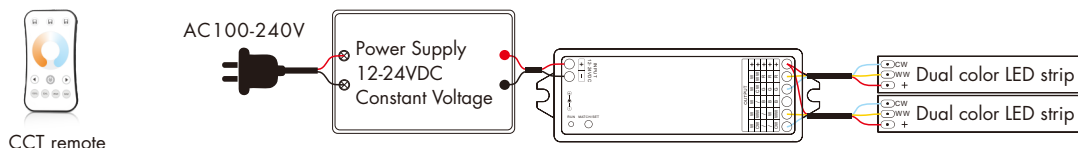

Press and hold match/set key for 10s, until the RUN LED indicator turn yellow, then release, the controller will become CCT type, then do smart config by Tuya smart APP, or short press match key to match with CCT RF remote.

### • For single color

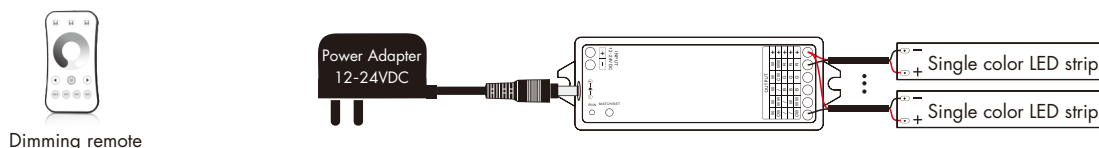

Press and hold match/set key for 8s, until the RUN LED indicator turn white, then release, the controller will become DIM type, then do smart config by Tuya smart APP, or short press match key to match with dimming RF remote.

### Note:

1. User can connect constant voltage power supply or power adapter as power input.
2. Press and hold Match/Set key for 2s, switch 5 kinds light type in sequence.
3. For RGB+CCT or CCT light type, continuous power on and off will change 3 levels color temperature (WW, NW and CW) in sequence.
4. Switch off the power, then switch on power, repeat again.  
Immediately short press match key 3 times, the light on/off time will change between 3s and 0.5s.

## Tuya Smart APP network connection

Press and hold Match/Set key for 2s:

Switch 5 kinds light type in sequence, notice this operation does not automatically clear previous network connection.

Press and hold Match/Set key for 5s, or push twice Match/Set key fastly, or when press and hold Match/Set key for 8-16s to set 5 kinds light type: Clear previous network connection, enter config mode, the purple LED indicator fast flash, the output LED will flash 10 times.

Repeat power on and off for 5 consecutive times, also clear previous network connection, enter config mode, the output LED will flash 10 times.

If Tuya smart APP network connection succeed, the RUN LED indicator will stop flash purple, and turn corresponding light type color (White: DIM, Yellow: CCT, Red: RGB, Green: RGBW, Blue: RGB+CCT).

and in Tuya smart APP, you can find ZB-RGB+CCT device (or other DIM, CCT, RGB or RGBW).

## Tuya Smart APP interface

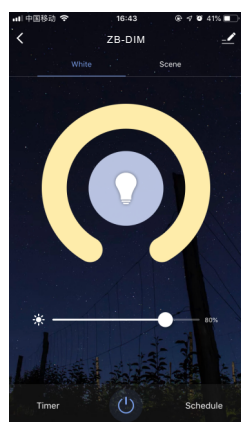

### White interface

For DIM type:  
Touch brightness slide to adjust brightness.

For RGB type:  
Touch brightness slide, get RGB mixed white firstly, then to adjust white brightness.

For RGBW type:  
Touch brightness slide, adjust white channel brightness.

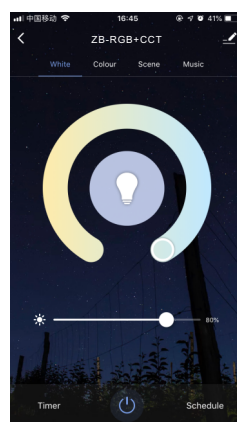

### Color temperature interface

For CCT type:  
Touch color wheel to adjust color temperature.  
Touch brightness slide to adjust brightness.

For RGB+CCT type:  
Touch color wheel to adjust color temperature,  
RGB will turn off automatically.  
Touch brightness slide to adjust white brightness.

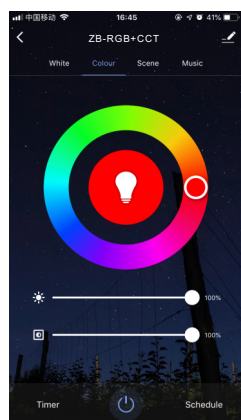

### Colour interface

For RGB or RGBW type:  
Touch color wheel to adjust static RGB color.  
Touch brightness slide to adjust color brightness.  
Touch saturation slide to adjust color saturation,  
namely gradient from the current color to white(RGB mixed).

For RGB+CCT type:  
Touch color wheel to adjust static RGB color, WW/CW will turn off automatically.  
Touch brightness slide to adjust color brightness.  
Touch saturation slide to adjust color saturation,  
namely gradient from the current color to white (RGB mixed).

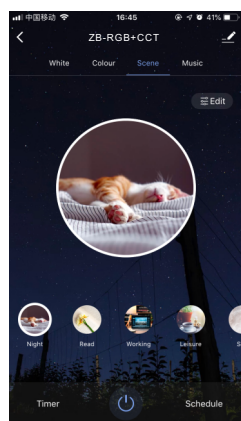

### Scene interface

The 1-4 scene is static color for all light type.  
the inner color of these scene can be editable.

The 5-8 scene is dynamic mode for RGB,  
RGBW, RGB+CCT type, such as green  
fade in and fade out, RGB jump,  
6 color jump, 6 color smooth.

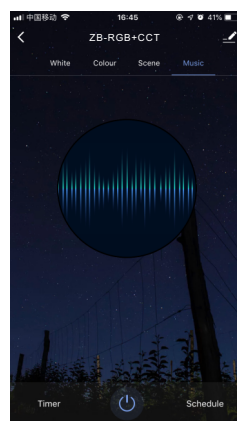

### Music, Timer, Schedule

The music play can use smart phone music player or  
micro-phone as music signal input.

The Timer key can turn on or turn off light in the next  
24 hours.

The Schedule key can add multiple timers to turn on  
or turn off light according to different time periods.

## WZ5 match RF remote control (Optional)

End user can choose the suitable match/delete ways. Two options are offered for selection:

### Use the WZ5's Match key

Match:

Short press match key of WZ5,  
immediately press on/off key (single zone remote)  
or zone key (multiple zone remote) on the remote.  
The LED indicator fast flash a few times means match is successful.

Delete:

Press and hold match key of WZ5 for 20s,  
The LED indicator fast flash a few times  
means all matched remotes were deleted.

### Use Power Restart

Match:

Switch off the power of WZ5, then switch on power, repeat again.  
Immediately short press on/off key (single zone remote)  
or zone key (multiple zone remote) 3 times on the remote.  
The light blinks 3 times means match is successful.

Delete:

Switch off the power of WZ5, then switch on power, repeat again.  
Immediately short press on/off key (single zone remote)  
or zone key (multiple zone remote) 5 times on the remote.  
The light blinks 5 times means all matched remotes were deleted.

## WZ5 work as ZigBee-RF converter to match RF LED controller or dimming driver

End user can choose the suitable match/delete ways. Two options are offered for selection:

### Use the controller's Match key

Match:

Short press match key of the controller,  
immediately press on/off key on the Tuya smart APP.  
The LED indicator fast flash a few times means match is successful.

Delete:

Press and hold match key of the controller for 5s,  
The LED indicator fast flash a few times means match was deleted.

### Use Power Restart

Match:

Switch off the power of the controller, then switch on power, repeat again.  
Immediately short press on/off key 3 times on the Tuya smart APP.  
The light blinks 3 times means match is successful.

Delete:

Switch off the power of the controller, then switch on power, repeat again.  
Immediately short press on/off key 5 times on the Tuya smart APP.  
The light blinks 5 times means match was deleted.

## RGB dynamic mode list

For RGB/RGBW:

No.	Name	No.	Name
1	RGB jump	6	RGB fade in and out
2	RGB smooth	7	Red fade in and out
3	6 color jump	8	Green fade in and out
4	6 color smooth	9	Blue fade in and out
5	Yellow cyan purple smooth	10	White fade in and out

For RGB+CCT:

No.	Name	No.	Name
1	RGB jump	6	RGB fade in and out
2	RGB smooth	7	Red fade in and out
3	6 color jump	8	Green fade in and out
4	6 color smooth	9	Blue fade in and out
5	Color temperature smooth	10	White fade in and out