

TD1-S, TD2-S, TD3-S, TD4-S, TD5-S

DT6/DT8 DALI Touch Panel



TD1-S
Single color

TD2-S
Dual color

TD3-S
RGB

TD4-S
RGBW

TD5-S
RGB+CCT

TD1/2/3/4/5-S is a series of 1-5 colour DALI touch master panels for controlling lighting control systems and DALI DT6/DT8 devices for use in a wide range of schools, retail, hospitals and offices.

- 1 DALI address, support DT6 dimming, DT8-TC color temperature, DT8-RGB or DT8-RGBW.
- Powered by DALI bus or 24VDC.
- DALI-2 certified, in accordance with DALI standard protocol IEC 62386-101, 103 and in compliance with DALI products from other international incorporation.
- Encoding switch select addresses, support 4 control modes: scene, grouping, unicast and broadcast.
- Match with RF 2.4G single zone or multiple zone remote control optional.
- Ultra sensitive high strength glass touch panel with touch color slide.
- Smooth and accurate color adjustment by touching the color slide.
- 4 scenes memory.
- Touch keys with LED indicator.
- White & Black glass panel available.

Technical Parameters

Input and Output		Dimming data		Safety and EMC	
Power supply	DALI bus/24VDC	Input signal	Touch key + RF 2.4GHz	EMC standard (EMC)	ETSI EN 301 489-1 V2.2.3 ETSI EN 301 489-17 V3.2.4
Static current	17mA@16VDC, 2mA@24VDC	RF Control distance	10m(Barrier-free space)	Safety standard	EN 62368-1:2020+A11:2020
Output signal	DALI	Dimming level	256 levels	Radio Equipment(RED)	ETSI EN 300 328 V2.2.2
Environment		Dimming range	0 - 100%	Certification	CE,EMC,RED,DALI 2
Operation temperature	Ta: -20°C ~ +50°C	Package		Warranty	
Case temperature (Max.)	Tc: +65°C	Size	L112 x W112 x H50mm	Warranty	5 years
IP rating	IP20	Gross weight	0.230kg		

Mechanical Structures

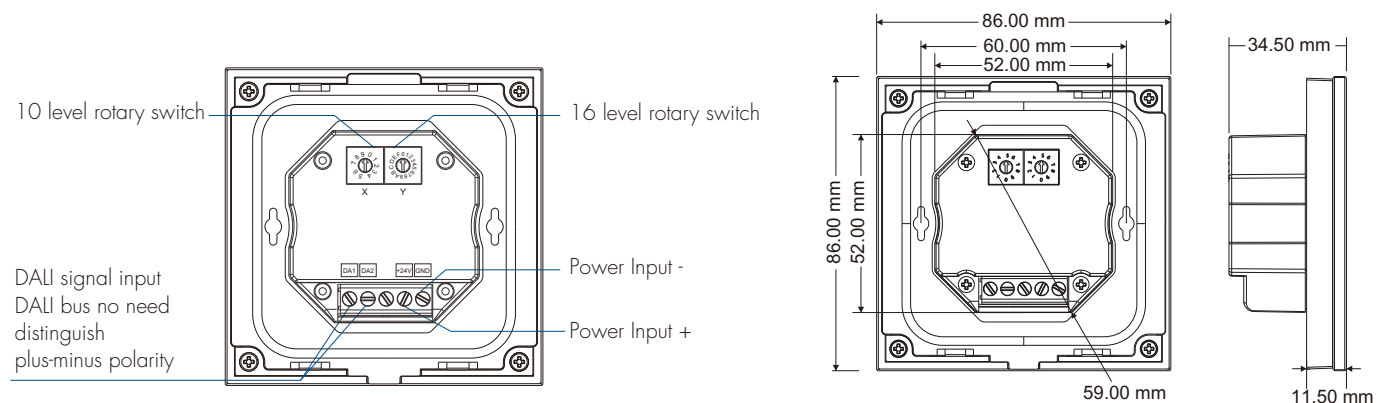

Key function

● TD1-S Single color panel

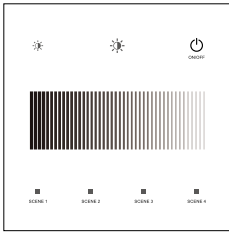

- Turn on/off light.
- Increase brightness, 10 level.
- Decrease brightness, 10 level.
- Brightness slide.
- Short press recall the scene, long press 5s save current brightness into scene 1/2/3/4.

● TD2-S Dual color panel

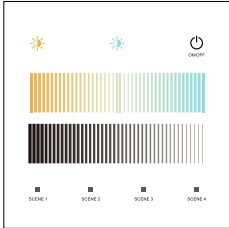

- Turn on/off light.
- Increase color temperature, 10 levels.
- Decrease color temperature, 10 levels.
- Color temperature slide.
- Brightness slide.
- Short press recall the scene, long press 5s save current color into scene 1/2/3/4.

● TD3-S RGB panel

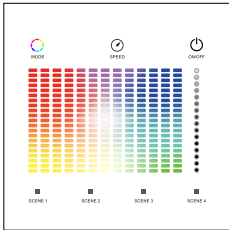

- Turn on/off light.
- Short press play 10 built-in dynamic mode, long press 2s run mode-cycle.
- Adjust dynamic mode speed, 10 levels.
- Color slide.
- Brightness slide.
- Short press recall the scene, long press 5s save current color into scene 1/2/3/4.

● TD4-S RGBW panel

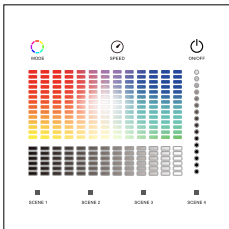

- Turn on/off light.
- Short press play 10 built-in dynamic mode, long press 2s run mode-cycle.
- Adjust dynamic mode speed, 10 levels.
- Color slide.
- W channel brightness slide.
- Brightness slide.
- Short press recall the scene, long press 5s save current color into scene 1/2/3/4.

● TD5-S RGB+CCT panel

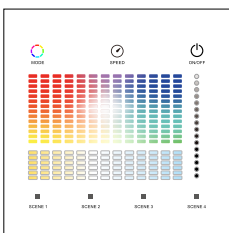

- Turn on/off light.
- Short press play 10 built-in dynamic mode, long press 2s run mode-cycle.
- Adjust dynamic mode speed, 10 levels.
- Color slide.
- Color temperature slide.
- Brightness slide.
- Short press recall the scene, long press 5s save current color into scene 1/2/3/4.

Scene locking:

- Scene keys can be set to locked state, cancel long press for 5 seconds to save the scene function (default scene is not locked).
- Short press the panel on/off key, turn on the light first, then turn off the light, immediately long press the panel on/off key for 5 seconds, then immediately long press any one scene key for 5 seconds to set all scene keys to locked state.
- Short press the panel on/off key, turn on the light first, then turn off the light, immediately long press the panel on/off key for 5 seconds, then immediately long press any one scene key for 10 seconds to restore all scene keys to unlocked state.

Wiring Diagram

Panel connect with multiple DALI LED dimmers (panel powered by 24VDC):

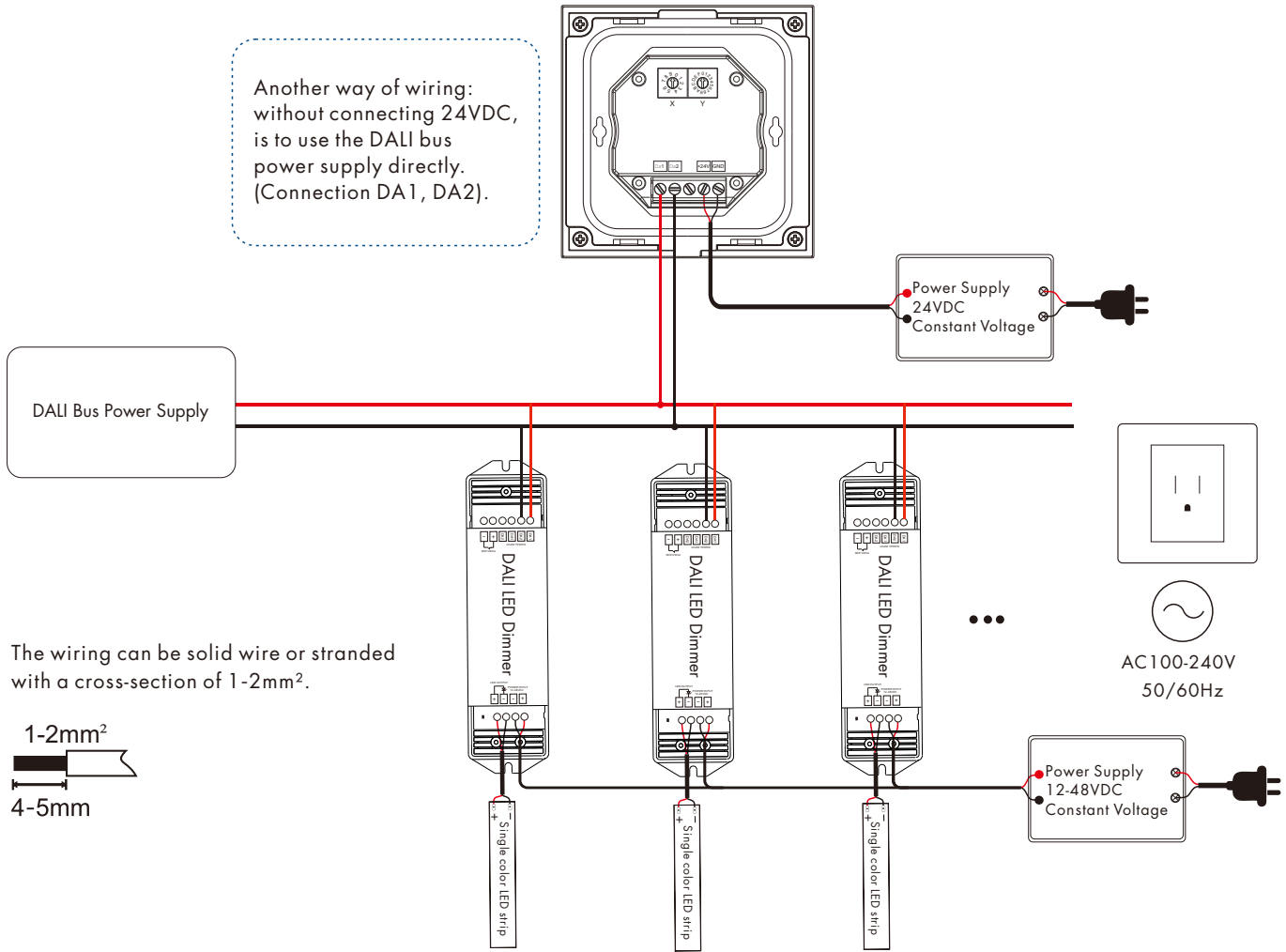

Panel installation diagram:

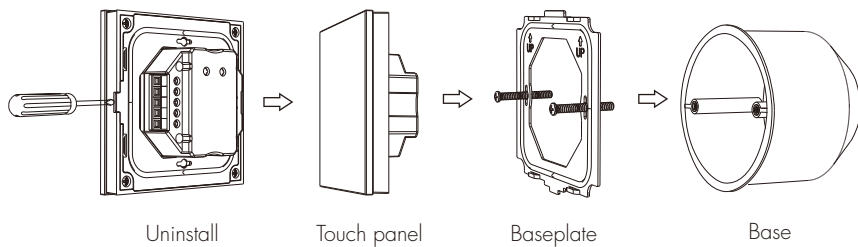

Typical base as below:

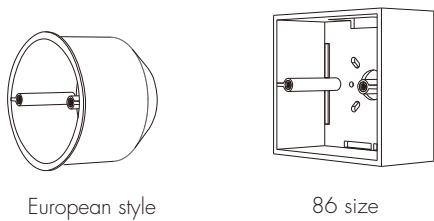

⚠ Note:

1. This product does not have a built-in DALI bus power supply and needs to be used with a DALI bus power supply.
2. It is recommended to use a 24VDC power supply for the touch panel DALI master to reduce the load on the DALI bus power supply.
3. The max. cable length of the DALI control cable must not exceed 300m, or a voltage drop of 2V must not be exceeded.
4. DO NOT install with power applied device.

Touch Panel DALI master match RF remote

Touch panel DALI master can also match with RF 2.4G remote (Optional).

End user can choose the suitable match/delete ways. Two options are offered for selection:

Use On/Off key

Match:

Turn on light, turn off, immediately press the On/Off key of the panel for 5s, then press any On/Off key of the RF remote within 5s.

The LED indicator fast flash 3 times means match is successful.

Delete:

Turn on light, turn off, immediately press the On/Off key of the panel for 10s to delete all match,

The LED indicator fast flash 6 times means all matched remotes were deleted.

Use Power Restart

Match:

Switch off the power of the panel, then switch on power, repeat again.

Immediately short press On/Off key 3 times on the remote.

The LED indicator fast flash 3 times means match is successful.

Delete:

Switch off the power of the panel, then switch on power, repeat again.

Immediately short press On/Off key 5 times on the remote.

The LED indicator fast flash 6 times means all matched remotes were deleted.

DALI address setting

Address value = X * 10 + Y.

For example: X = 5, Y = 4, Address value = 5 x 10 + 4 = 54.

Unicast mode

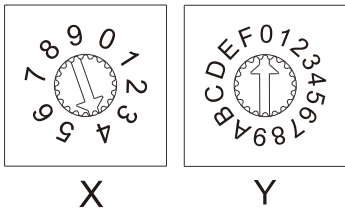

X is 0-6, Y is 0-9.

Address value 0-63 correspond to DALI unicast address 00-63.

For example:

Address value = 40, the unicast address value is 40.

Group mode

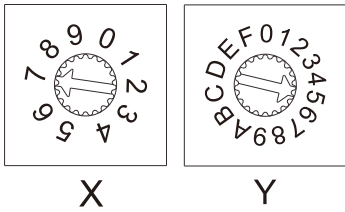

X is 7, Y is 0-F.

Address value 70-7F correspond to DALI group address 0-15.

For example:

Address value = 5, the group address value is 5.

Broadcast mode

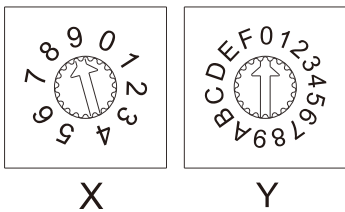

X is 9, Y is 0-F.

Address value 90 - 9F correspond to broadcast address.

RGB/RGBW dynamic mode list (only for TD3-S / TD4-S)

No.	Name	No.	Name
1	RGB jump	6	RGB fade in and out
2	RGB smooth	7	Red fade in and out
3	6 color jump	8	Green fade in and out
4	6 color smooth	9	Blue fade in and out
5	Yellow cyan purple smooth	10	White fade in and out

RGB+CCT dynamic mode list (only for TD5-S)

No.	Name	No.	Name
1	RGB jump	6	RGB fade in and out
2	RGB smooth	7	Red fade in and out
3	6 color jump	8	Green fade in and out
4	6 color smooth	9	Blue fade in and out
5	Color temperature smooth	10	White fade in and out