

T1-1, T2-1, T3-1, T4-1

RF DIM/CCT/RGB/RGBW

Wall Mounted Touch Panel



- Touch panel single color, dual color, RGB or RGBW PWM constant voltage controller.
- Ultra sensitive high strength glass touch panel with touch color slide in the middle.
- Compatibility with RF 2.4G single zone or multiple zone remote control.
- White & Black glass panel available.

CE RoHS RED

Technical Parameters

Input and Output					Safety and EMC	
Model No.	T1-1	T2-1	T3-1	T4-1	EMC standard	EN 62479:2010 ETSI EN 301 489-1 V2.2.3 ETSI EN 301 489-17 V3.2.4
Input voltage	12-48VDC	12-48VDC	12-24VDC	12-24VDC	Safety standard	EN 61347-1:2015+A1:2021 EN 61347-2-13:2014+A1:2017
Input current	10.5A	10.5A	12.5A	12.5A	Radio Equipment	ETSI EN 300 328 V2.2.2
Output voltage	2 x (12-48)VDC	2 x (12-48)VDC	3 x (12-24)VDC	4 x (12-24)VDC	Certification	CE RED
Output current	2CH, 5A/CH@12-24V 3A/CH@36-48V	2CH, 5A/CH@12-24V 3A/CH@36-48V	3CH,4A/CH	4CH,3A/CH	Environment	
Output power	120-288W	120-288W	144-288W	144-288W	Operation temperature	Ta: -30°C ~ +55°C
Output type	Constant voltage	Constant voltage	Constant voltage	Constant voltage	Case temperature (Max.)	Tc: +85°C
PWM frequency	1K/2K/8K/16KHz	2K/8KHz	1KHz	1KHz	Package	
Light type	Single color	Dual color	RGB	RGBW	Size	L112 x W112 x H50mm
					Gross weight	0.231kg

Mechanical Structures and Installations

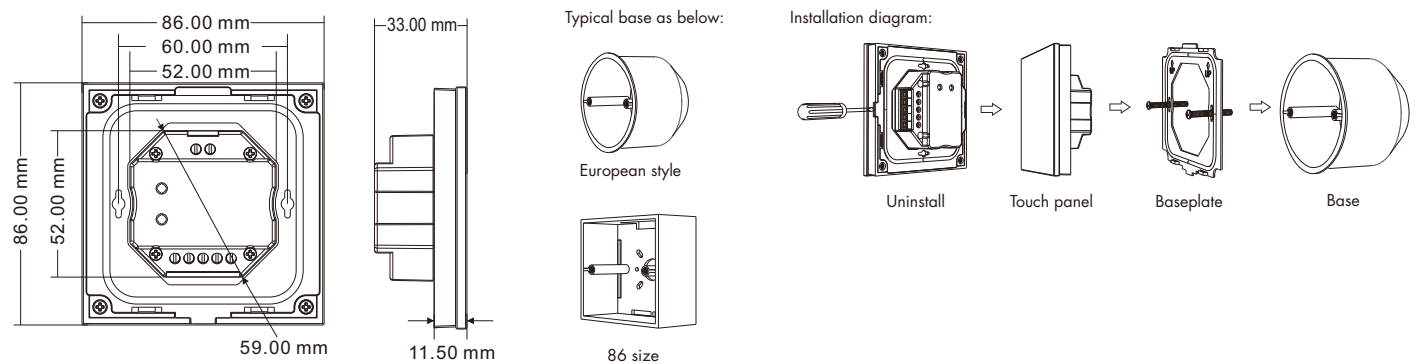

Match Remote Control (two match ways)

The touch panel controller can also match with the RF remote (optional). End user can choose the suitable match/delete ways. Two options are offered for selection:

Use On/Off key

Match:

Turn on light, turn off, immediately press the On/Off key of the panel for 5s, then press on/off key (single zone remote) or zone key (multiple zone remote) of the RF remote within 5s. The LED indicator fast flash 3 times means match is successful.

Delete:

Turn on light, turn off, immediately press the On/Off key of the panel for 10s, delete all matched RF remote. The LED indicator fast flash 6 times means all matched remotes were deleted.

Use Power Restart

Match:

Switch off the power, then switch on power, repeat again, immediately short press on/off key (single zone remote) or zone key (multiple zone remote) 3 times on the remote. The light blinks 3 times means match is successful.





Delete:

Switch off the power, then switch on power, repeat again, immediately short press on/off key (single zone remote) or zone key (multiple zone remote) 5 times on the remote. The light blinks 5 times means all matched remotes were deleted.

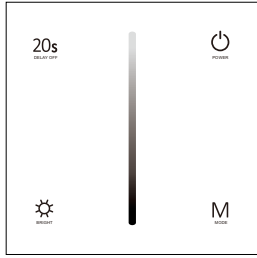
Key function





• T1-1 Single color panel



-  — Turn on/off light.
-  — Brightness slide.
-  — Brightness, 10 levels.
-  — Turn off light after 20s.
-  — Dynamic mode, 6 level speed.







• T2-1 Dual color panel

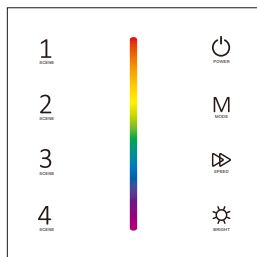

-  — Turn on/off light.
-  — Color temperature.
-  — Brightness +, 10 levels.
-  — Brightness -, 10 levels.
-  — Dynamic mode, 6 level speed.





• T3-1 RGB panel

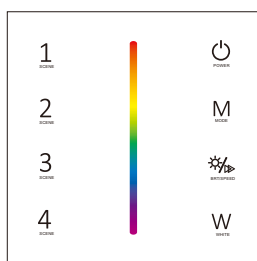

-  — Turn on/off light.
-  — Color slide.
-  — Brightness, 10 levels.
-  — Adjust dynamic mode speed, 10 levels.
-  — Short press play 10 built-in dynamic mode, long press 2s run mode-cycle.
-  — 4 Scenes, short press recall scene.
Long press 2s to save the current color into 1/2/3/4.

• T4-1 RGBW panel

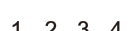

-  — Turn on/off light.
-  — Color slide.
-  — Adjust dynamic mode speed or static color brightness, 10 levels.
-  — Short press play 10 built-in dynamic mode, long press 2s run mode-cycle.
-  — Short press turn on/off W channel, long press adjust W channel brightness.
-  — 4 Scenes, short press recall scene.
Long press 2s to save the current color into 1/2/3/4.

Turn on key tone: Long press power key for 5s when light is off, will turn on or turn off key tone(T1-1 ,T2-1 without key tone).

Wiring diagram

• T1-1 Single color panel

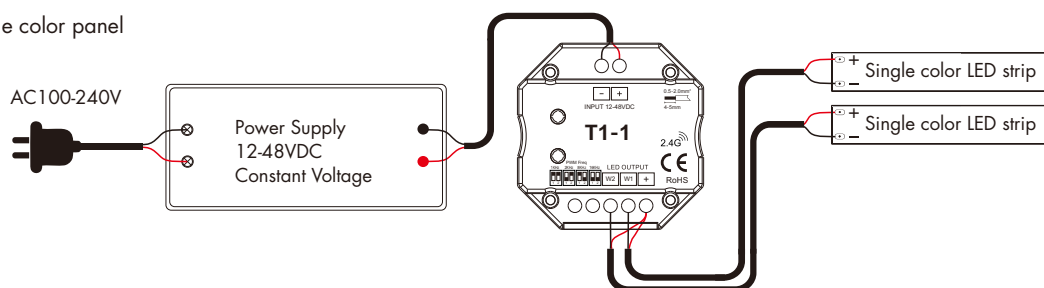

DIP switch select four PWM frequency: 1KHz, 2KHz, 8KHz or 16KHz.

Higher PWM frequency, will cause lower output current, higher power noise, but more suitable for camera(No flickers for video).

• T2-1 Dual color panel

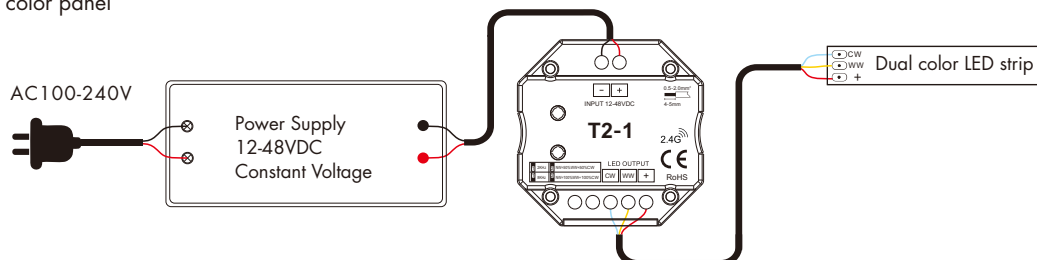

DIP switch 1 select two PWM frequency: 2KHz or 8KHz.

Higher PWM frequency, will cause lower output current, higher power noise, but more suitable for camera(No flickers for video).

DIP switch 2 select color temperature output mode: $NW=50\%WW+50\%CW$ or $NW=100\%WW+100\%CW$.

• T3-1 RGB panel

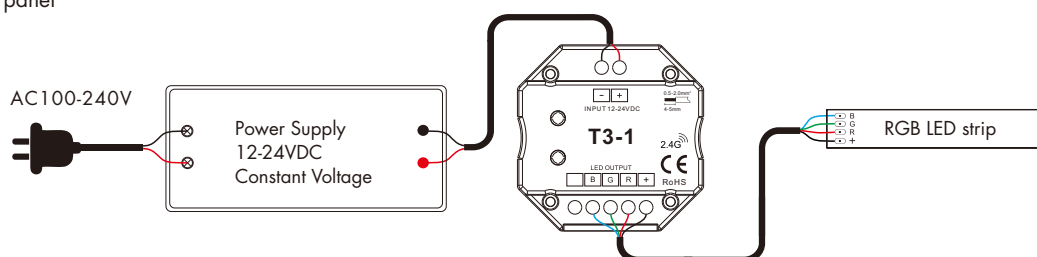

• T4-1 RGBW panel

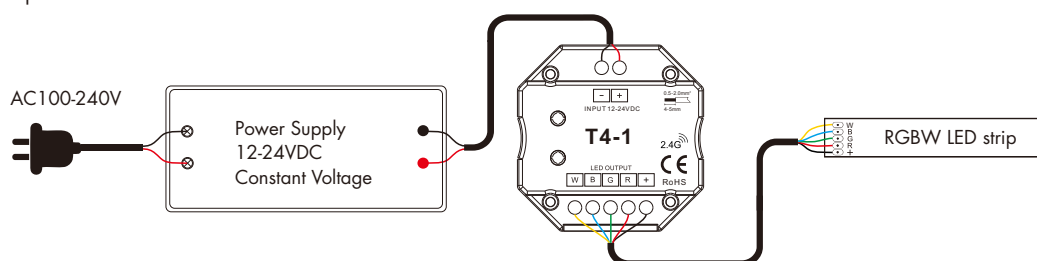

RGB/RGBW dynamic mode list (only for T3-1 / T4-1)

No.	Name	No.	Name
1	RGB jump	6	RGB fade in and out
2	RGB smooth	7	Red fade in and out
3	6 color jump	8	Green fade in and out
4	6 color smooth	9	Blue fade in and out
5	Yellow cyan purple smooth	10	White fade in and out