

Wall Mounted Rotary Panel

Model No.: T1-K, T2-K, T3-K

1-3 color/Glass panel/Rotary dimming/DC input/3 channel constant voltage PWM output/Wireless remote control

Features

- Rotary panel single color, dual color or RGB PWM constant voltage controller.
- Rotate knob to change RGB color, color temperature or brightness.
- 256 levels 0-100% dimming smoothly without any flash.
- Compatibility with RF 2.4G single zone or multiple zone remote control.
- PWM frequency 2KHz or 8KHz selectable.
- Push/Rotate with LED indicator.
- Over-heat / Over-load / Short circuit protection, recover automatically.
- White & Black glass panel available.



T1-K

T2-K

T3-K

CE RoHS RED

Technical Parameters

Input and Output	T1-K	T2-K	T3-K
Model No.	T1-K	T2-K	T3-K
Input voltage	12-48VDC	12-48VDC	12-48VDC
Input current	12.5A	10.5A	12.5A
Output voltage	3 x (12-48)VDC	2 x (12-48)VDC	3 x (12-48)VDC
Output current	3CH,4A/CH	2CH,5A/CH	3CH,4A/CH
Output power	3 x (48-192)W	2 x (60-240)W	3 x (48-192)W
Output type	Constant voltage	Constant voltage	Constant voltage
PWM frequency	2K/8KHz	2K/8KHz	2K/8KHz
light type	Single color	Dual color	RGB

Safety and EMC	
EMC standard (EMC)	ETSI EN 301 489-1 V2.2.3 ETSI EN 301 489-17 V3.2.4
Safety standard	EN 62368-1:2020+A11:2020
Radio Equipment(RED)	ETSI EN 300 328 V2.2.2
Certification	CE,EMC,RED
Environment	
Operation temperature	Ta: -30 °C ~ +55 °C
Case temperature (Max.)	Ta: +85 °C
Package	
Size	L112 x W112 x H60mm
Gross weight	0.220kg

Mechanical Structures and Installations

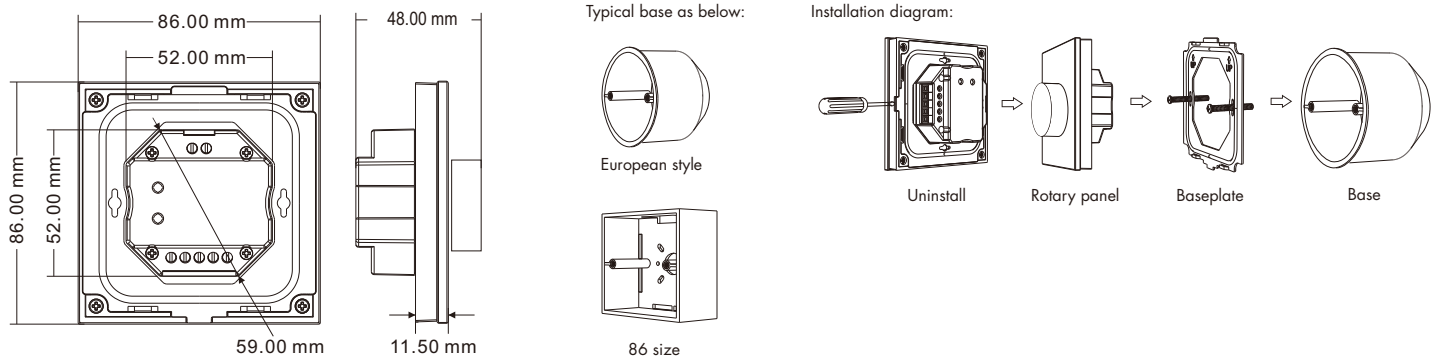

Match Remote Control (two match ways)

The rotary panel controller can also match with the RF remote (optional).
End user can choose the suitable match/delete ways. Two options are offered for selection:

Use Knob

Match:

Turn on light, turn off, immediately push the knob for 5s, then press on/off key (single zone remote) or zone key (multiple zone remote) of the RF remote with in 5s.
The LED indicator fast flash 3 times means match is successful.

Delete:

Turn on light, turn off, immediately push the knob for 10s, delete all matched RF remote.
The LED indicator fast flash 6 times means all matched remotes were deleted.

Use Power Restart

Match:

Switch off the power, then switch on power, repeat again, immediately short press on/off key (single zone remote) or zone key (multiple zone remote) 3 times on the remote.
The light blinks 3 times means match is successful.

Delete:

Switch off the power, then switch on power, repeat again, immediately short press on/off key (single zone remote) or zone key (multiple zone remote) 5 times on the remote.
The light blinks 5 times means all matched remotes were deleted.

Knob function

T1-K Single color dimmer



- **Push:** Turn on or off light.
After turn on light:
- **Rotate:** Rotate knob to adjust brightness (2.5 turns, 50 levels).
- **Long push(1-6s):** Continuous 256 levels brightness adjustment.

T2-K Dual color temperature

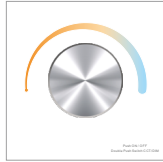

- **Push:** Turn on or off light.
After turn on light:
- **Rotate:** Rotate knob to change color temperature or brightness (2.5 turns, 50 levels).
- **Push twice:** Switch between color temperature or brightness adjustment.
- **Long push(1-6s):** Continuous 256 levels brightness adjustment.

T3-K RGB

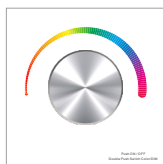

- **Push:** Turn on or off light.
After turn on light:
- **Rotate:** Rotate knob to change RGB color (3 turns, 60 colors) or brightness (2.5 turns, 50 levels).
- **Push twice:** Switch between RGB color or brightness adjustment.
- **Long push(1-6s):** Continuous 256 levels saturation or brightness adjustment.

Wiring diagram

• T1-K

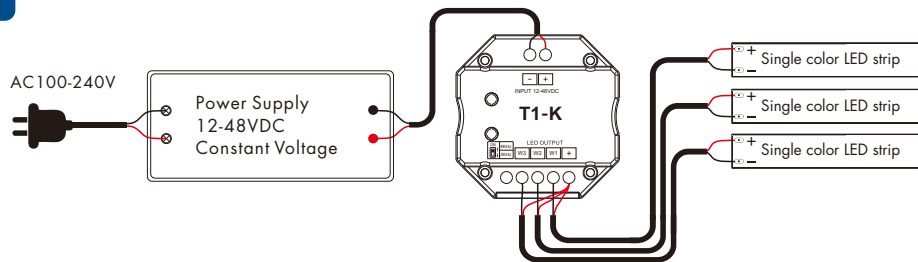

• T2-K

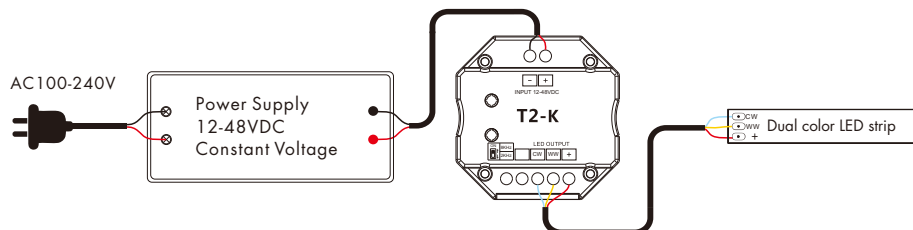

• T3-K

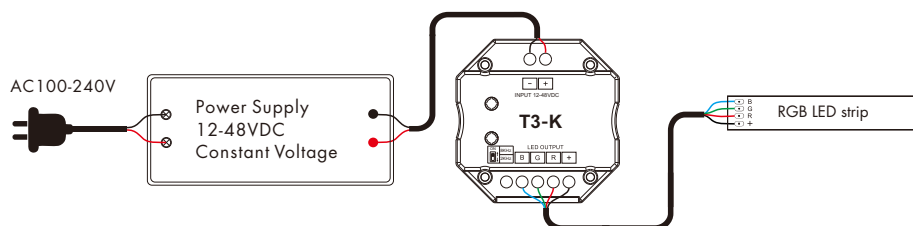

PWM frequency setting

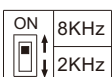

We can select 2KHz or 8KHz PWM frequency by one DIP switch.

Higher PWM frequency, will cause lower output current, higher power noise, but more suitable for camera(No flickers for video).