

WiFi & RF Constant Current CCT LED Driver

- Dimming interface: WiFi, RF Wireless.
- Tuya smart APP cloud control, support on/off, color temperature and brightness adjust, delay turn on/off light, timer run, scene edit and music play function.
- Voice control, support for Amazon Alexa, Google Assistant, Tmall Genie and Xiaodu voice assistant.
- Match with RF 2.4G color temperature remote control, one RF LED driver accepts up to 10 remote controls.
- Universal AC input / Full range.
- Flicker-free.
- 2 channel constant current output, configurable current via DIP switch.
- Fade in and out effect selectable .
- 3 levels color temperature (WW, NW and CW) selectable by continuous power off and on operation.
- Over-heat / Over-load / Short circuit protection, recover automatically.
- Full protective plastic case.
- Suitable for indoor LED lighting application.
- 5 Year, 50,000hr warranty.

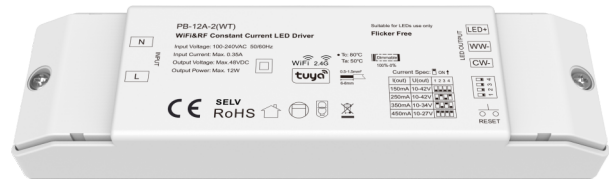

Applications

- Suitable for downlight, spotlight and decorative applications.
- Office / Commercial / Domestic Lighting, Hotels, Classrooms, Warehouse, Health care, Retail and Display.
- Use for retrofit upgrades & new luminaire designs.

Mechanical Structures and Installations

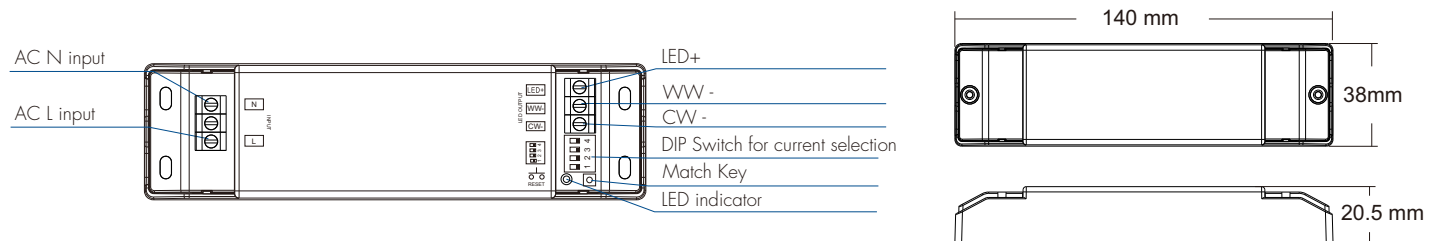

Technical Parameters

Output	Output Voltage	10~42VDC
	Output Current	2x(150~450)mA
	Output Power	Max. 12W
	Max Output Voltage	48VDC
	Dimming Range	0~100%
	PWM Frequency	4000Hz
	Current Accuracy	±5%
Input	Input Voltage Range	100~240VAC
	Frequency Range	50/60Hz
	Efficiency	80%
	Input Current	0.35A Max.
	Anti Surge	I:N:1.2KV
	Startup time	1S/230VAC
	Inrush Current	Cold start 14.5A at 230VAC
	Leakage Current	< 0.5mA/230VAC
Protection	No Load Power	<2W
	Over heat	Hiccup,recovers automatically after fault condition is removed
	Overload	Hiccup,recovers automatically after fault condition is removed
Environment	Short circuit	Hiccup,recovers automatically after fault condition is removed
	Working Temperature	-20°C~50°C
	T _{case} Max	80°C
	Working Humidity	20%~90%RH, non-condensing
	Storage Temp/Humidity	-40°C~80°C, 10%~95%RH
	Temperature Coefficient	±0.03%/°C (0-50%)
	Vibration Resistance	10-500Hz, 2G, 6min/cycle, X,Y,Z axes/2min
IP Rating	IP20	
Safety&EMC	Security Specifications	IEC/EN61347-1, IEC/EN61347-2-13
	Withstand Voltage	I/P/O/P: 3750VAC
	Insulation Resistance	I/P/O/P: 100M/500VDC/25°C/70%RH
	EMC Emission	EN61000-3-2 Class C, IEC61000-3-3
	EMC Immunity	EN61000-4-2.3.4.5.6.8.11, EN61547
	Certifications	CE, ROHS

LED Current Selection:

ON ↑	1 2 3 4	<input type="checkbox"/>	<input type="checkbox"/>	<input type="checkbox"/>	<input type="checkbox"/>	<input type="checkbox"/>	<input type="checkbox"/>	<input type="checkbox"/>	<input type="checkbox"/>	<input type="checkbox"/>	<input type="checkbox"/>	<input type="checkbox"/>	<input type="checkbox"/>	<input type="checkbox"/>	<input type="checkbox"/>	<input type="checkbox"/>	<input type="checkbox"/>	<input type="checkbox"/>	<input type="checkbox"/>	<input type="checkbox"/>	<input type="checkbox"/>
	Uout	10-42V				10-42V				10-34V				10-27V							
OFF ↓	Iout	150mA				250mA				350mA				450mA							

System wiring

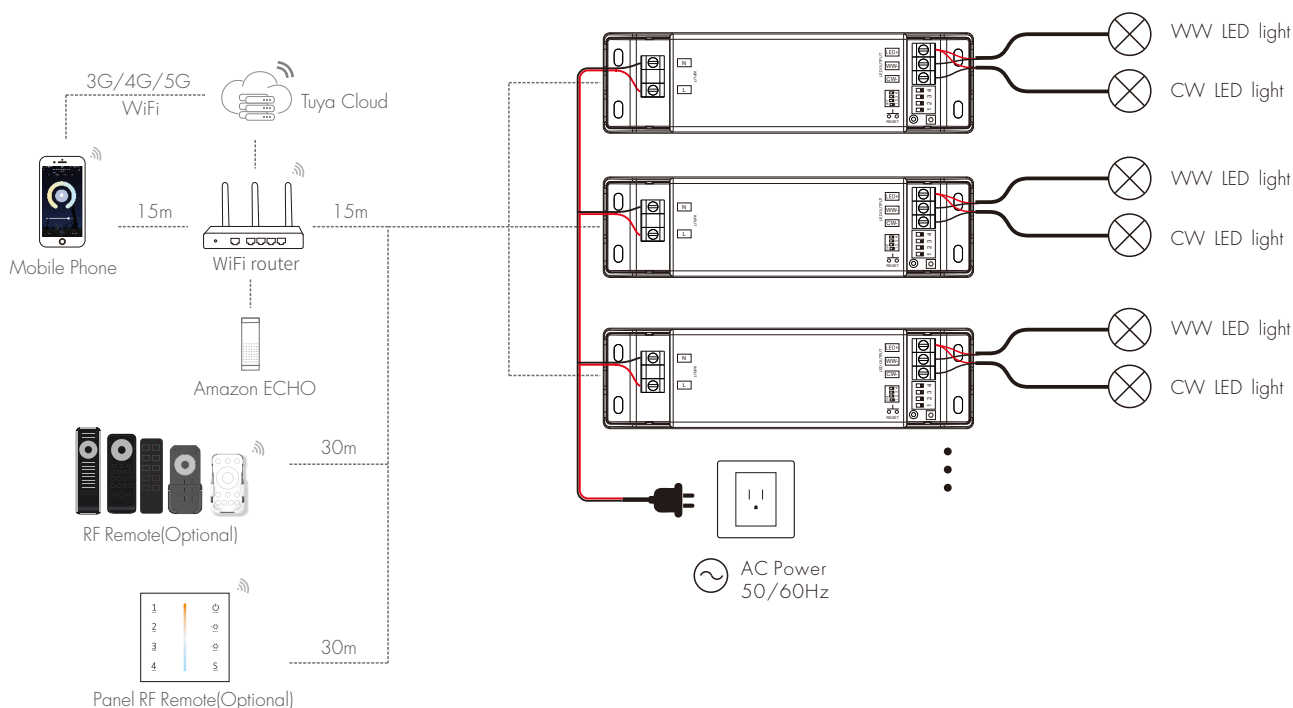

Note:

1. The above distance is measured in spacious (no obstacle) environment, Please refer to the actual test distance before installation.
2. Please check if the WiFi router net in 2.4G band, the 5G band is not available, and do not hide your router network.
3. Please keep the distance between LED driver and router close, and check the WiFi signals.
4. Continuously switch off and on the LED driver rapidly, It will change 3 levels color temperature (WW, NW and CW) in sequence.

Match Remote Control (two match ways)

End user can choose the suitable match/delete ways. Two options are offered for selection:

Use Match key

Match:

Short press match key, immediately press on/off key (single zone remote) or zone key (multiple zone remote) of the remote.

Delete:

Press and hold match key for 10s to delete all match, The light blinks 5 times means all matched remotes were deleted.

Use Power Restart

Match:

Switch off the power, then switch on power, repeat again. Immediately short press on/off key (single zone remote) or zone key (multiple zone remote) 3 times on the remote. The light blinks 3 times means match is successful.

Delete:

Switch off the power, then switch on power, repeat again. Immediately short press on/off key (single zone remote) or zone key (multiple zone remote) 5 times on the remote. The light blinks 5 times means all matched remotes were deleted.

Fade in and Fade out Setting

Switch off the power, then switch on power, repeat again.

Immediately short press match key 3 times, the light on/off time will change between 3s and 0.5s.

Tuya Smart APP network connection

Press and hold Match key for 2s, or push twice Match key fastly:

Clear previous network connection, enter Smart config mode, the blue LED indicator flash fastly, the output LED will flash 10 times.

Press and hold Match key for 5s:

Clear previous network connection, enter AP config mode, the blue LED indicator flash slowly.

If smart config failed, please try AP config.

Repeat power on and off for 5 consecutive times, also clear previous network connection, enter Smart config mode, the output LED will flash 10 times.

If Tuya smart APP network connection succeed, the blue LED indicator will stop flash, and in Tuya smart APP, you can find CCT device.

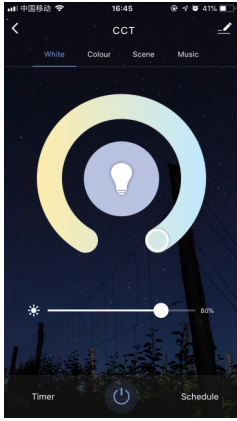

Color temperature interface

For CCT type:

Touch color wheel

to adjust color temperature.

Touch brightness slide

to adjust brightness.

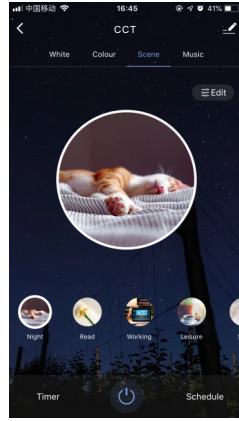

Scene interface

The 1-4 scene is static color.

the inner color of these scene can be editable.

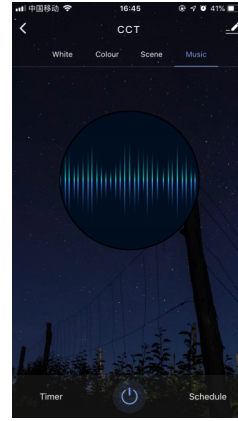

Music, Timer, Schedule

The music play can use smart phone music player or micro-phone as music signal input.

The Timer key can turn on or turn off light in the next 24 hours.

The Schedule key can add multiple timers to turn on or turn off light according to different time periods.

Installation precautions

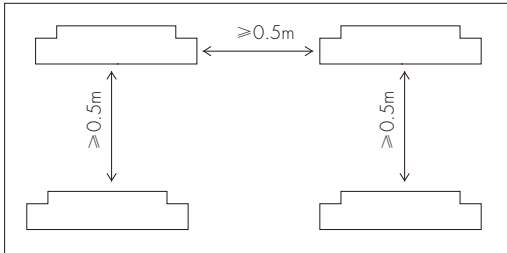

1. The products shall not be stacked, the distance should be $\geq 50\text{cm}$, so as not to affect lifespan of the products due to poor heat dissipation.
2. The installation height shall be $\geq 1\text{m}$ from the floor to avoid shortening the remote control distance due to too weak reception signal.
3. The products are not allowed to be close to or covered by metal objects, with an interval of $\geq 20\text{cm}$ to avoid signal attenuation and shorten the remote control distance.
4. Avoid installation at the corner of the wall or the corner of the beam, with an interval of $\geq 20\text{cm}$ to avoid signal interference.

Failure analysis and troubleshooting

Fault	Cause	Solution
The light can not be turned on	<ol style="list-style-type: none"> 1. No power 2. Wrong wiring 	<ol style="list-style-type: none"> 1. Check the power supply 2. Connection test
Remote control nonresponse	<ol style="list-style-type: none"> 1. Run out of battery 2. Beyond remote control range 3. No matching 	<ol style="list-style-type: none"> 1. Replace the battery 2. Move the remote to controller closer 3. Match the remote to LED driver
Hiccup flashing	Overload	Check the power of the light
Controlled by other remote	Wrong pairing	Delete all pairing and pair with remote again
Multiple LED drivers are out of sync	Inconsistent fade on/off time	Set the same fade on/off time