

LTECH



FC CE RoHS [warranty 5 years] ISO9001:2008

www.ltech-led.com

WiFi LED Controller

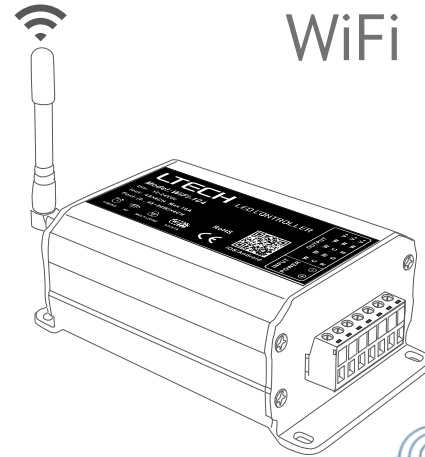

iOS

Andriod

Model: WiFi-104





WiFi-104 is a WiFi lighting control system, consisted of APPs and WiFi controller. Controls various types of LED lighting products by installing the related App on our iOS or Android mobile devices which support WiFi connection.

With DIM, CT adjustment, RGB and RGBW changing 4 in 1 operation, plus 12 zones control function, you can connect directly or by a router.

1. Product Parameter:

WiFi-104 Technical Parameters:

Communication Standard:	2.4GHz WiFi, 802.11b/g/n Protocol
Input Voltage:	12~24Vdc
Output Current:	4A×4CH Max 16A
Max Output Power:	[0~48W...96W]×4CH Max. 384W
Control Distance:	Max 100m
Output Control:	Dimming, CT, RGB, RGBW
Operating Temp.:	-30℃ ~55℃
Dimensions:	L128×W73×H45(mm)
Package Size:	L135×W80×H64(mm)
Weight [G.W.]:	390g

Software Technical Parameters:

Platform:	Android 4.0 or above, iOS 8.0 or above
Language:	English
Category:	Appliance

R4-5A Constant Voltage Zone Receiver

Wireless Frequency:	2.4GHz
Input Voltage:	5-24Vdc
Max Current Load:	5A×4CH Max 20A
Max Output Power:	[0~25W...120W]×4CH Max. 480W
Working Temp.:	-30℃~55℃
Dimensions:	L175×W44×H30(mm)
Package Size:	L178×W48×H33(mm)
Weight [G.W.]:	150g

R4-CC Constant Current Zone Receiver

Wireless Frequency:	2.4GHz
Input Voltage:	12-48Vdc
Output Voltage:	3-46Vdc
Output Current:	CC 350/700/1050mA×4CH
Output Power:	[1.05W~48.3W]×4CH Max. 193.2W
Working Temp.:	-30℃~55℃
Dimension:	L175×W44×H30(mm)
Package Size:	L178×W48×H33(mm)
Weight [G.W.]:	165g

Note: Receiver is sold separately

2. Configuration Diagram:

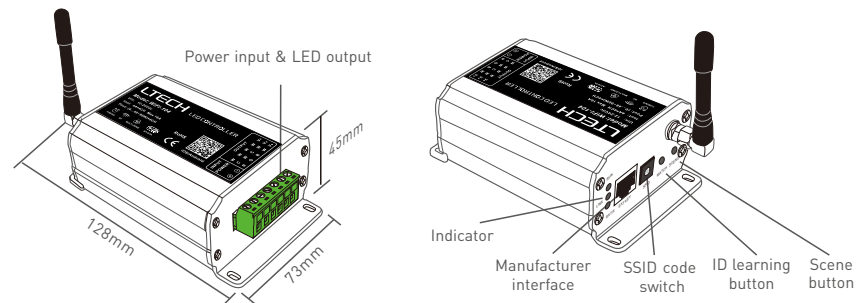

3. Controller Operating Instructions:

3.1 Install/Uninstall ANT:

Clockwise to install the WiFi-104 ANT, counterclockwise to take off.

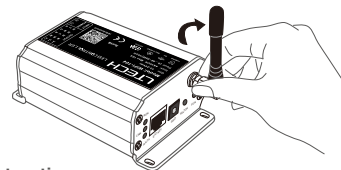

3.2 Work Status Indicator Instructions:

RUN: The indicator light flashes quickly about 25s during the electric initialization. Flashes once per second after initialization.

LINK: The indicator light stays lit when the mobile device connects to WiFi-104, and turns off when disconnect.

RX/TX: The indicator light turns on when WiFi-104 receives or transmits the WiFi data, turns off in the free time.

3.3 SSID Number Setting:

Use code switch to set the controller's SSID number, WiFi-104-SSID-X, X stands for a certain No. ranging from 0-F, totally 16 options. which means our product could set 16 isolated LAN in the same area. WiFi-104 will initialize with run LED indicator flashing about 25s quickly, each time the SSID NO. is changed. Mobile devices need to search and connect WiFi again after Initialization finished.

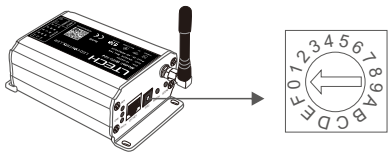

3.4 "MATCH" and "SCENE" Button:

Short press MATCH button, WiFi controller begins its learning ID status for M12 remote (learning method, see P13). Short press "SCENE" button entering into the user-saved scene modes sequentially, 4 scenes total.

[Restore factory settings/Delete password]

Long press "MATCH" and "SCENE" button simultaneously more than 2 seconds, the machine will back to the default parameter, including the parameters of changing modes, zone, group and network. Machine default parameters: Only the 1st zone is present, default RGBW mode, the changing mode is RGB jumping, white is the brightest, no groups, network SSID is WiFi-104-SSID-X (X is the actual coding switch corresponding SSID values), WiFi-104 controller restores as direct connection and the connection password is blank.

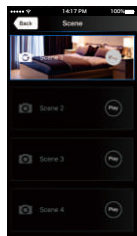
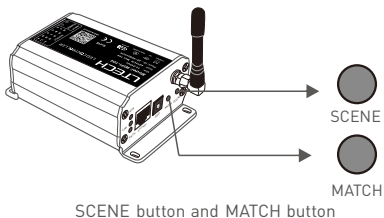

Scene interface

4. The Instructions of APP Software:

4.1. WiFi-104 Software Installation:

Scan QR Code to download the APP via mobile phone.



iOS/Android

4.2 Software Operating Instructions:

4.2.1 WiFi Connection and Settings

WiFi-104 support 2 connection modes: Direct connection as a router or connect by an additional router.

A. WiFi-104 Controller Direct Connection as a Router:

Enter mobile device's WiFi setting, click the WiFi function, mobile device search the WiFi and list the working WiFi controller automatically(As Figure-1), click the SSID number to connect (default is no password).





Android WiFi connection [Figure-1]



Apple WiFi connection

B. Connection with an Additional Router:

Connect WiFi-104 Controller to the Additional Router Network:

- a. Connect to the WiFi-104 controller, the same step as (4.2.1)
- b. Click mobile device's icon  to start the software, the software will search and list the working WiFi controller automatically, and there is a blue wireless icon  (as Figure-2-1)



WiFi-104 as a router interface (Figure-2-1)

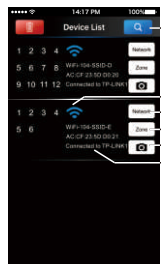

Connect an additional router interface (Figure-2-2)

- c. Click "Network" key to enter Network interface(as Figure-3-1), start "connect to exiting LAN", software will search the workable WiFi net SSID list, choose the specified router to connect (Attn: do not choose WiFi-104 controller), can add the WiFi-104 controller to the wireless router (as figure-3-2 the wireless router TP-LINK1)

Repeat the abc steps if you need connecting multiple WiFi-104 controllers to this wireless router

- d. Exit WiFi-104 software, enter mobile device setting-wireless network setting, choose the wireless router to connect. Device list interface shows as Figure 2-2 when re-opening the WiFi-104 software.

Now completes the steps to connect to the additional router.

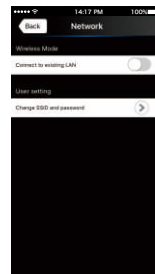

(Figure-3-1)

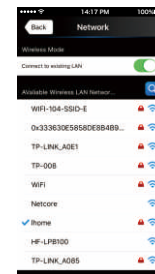

(Figure-3-2)

Network interface

Attn: In this connection mode, to avoid the mobile device automatically connect to WiFi-104 after the setting has completed, please click on the connected WiFi-104 which under the mobile device "WiFi setting". and at the message box please click "Ignore the network," (apple iOS) or "cancel save" (SAMSUNG mobile phone is "forget") to cancel the save of WiFi-104 connection.

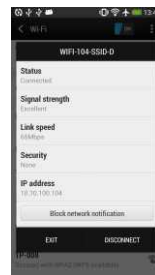

Android cancellation of the save of WiFi-104 connection

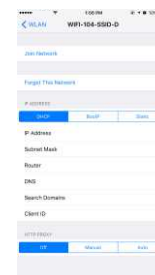

Apple cancellation of the save of WiFi-104 connection

4.2.2 Main Interface (5 types)

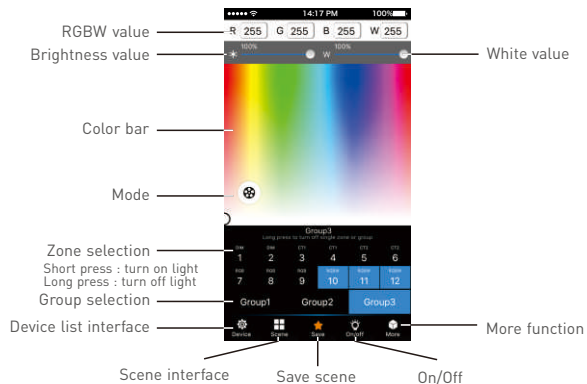

5 Main Interface

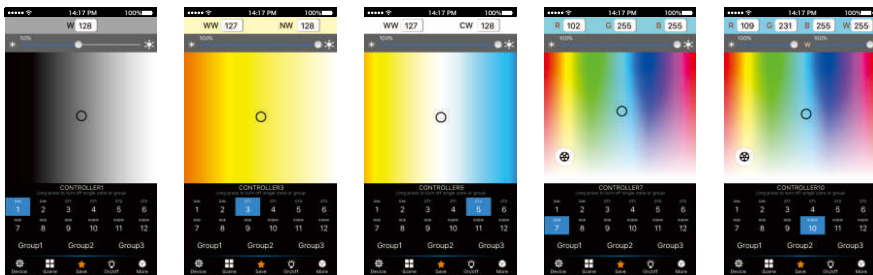

4.2.3 The Learning Method of Zone Control

A. Turn On Zones Control

Click "Zone" on the **Device List** interface, enter **Zone set** interface. turn on each zone, choose the LED type accordingly [zones are nameable].

[Attn]: WiFi-104 itself is defaulted as zone NO.1, connecting lights is optional, slave control will be zone NO.1 if not connected.

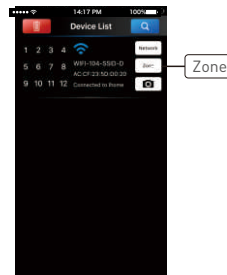

Device list interface

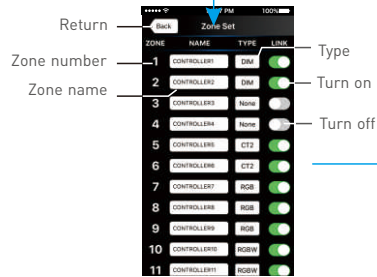

Zone set interface

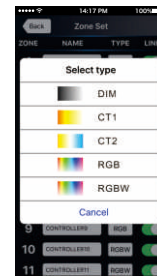

Select type interface

B. Learning ID:

Short press "ID learning button"  on the receiver, the running light keeps on, select the zone No. on the App and touch the color screen for 2s-3s. The buzzer long beep (meanwhile the running light on the receiver back to flash state), ID matched.

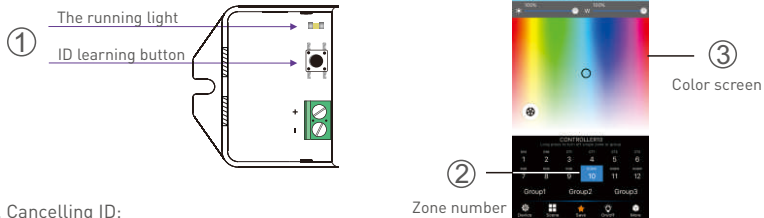



C. Cancelling ID:

Long press "ID learning button"  on the receiver for 5s, the buzzer long beep, ID cancelled.

[Attn]: Reset function is available during ID cancellation. Considering dysfunction in rare cases, please cancel the ID and re-sync.

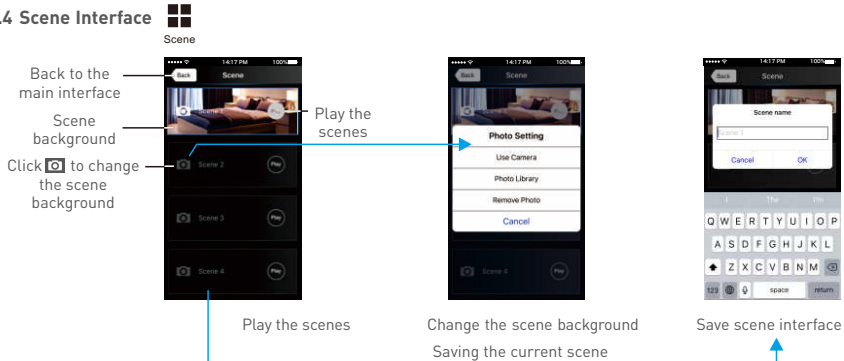
4.2.4 Scene Interface



4.2.5 Save scene  Save

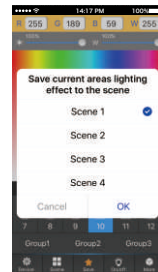

Save current areas lighting effect to the scene

4.2.6 Mode Interface for RGB / RGBW Type  Mode

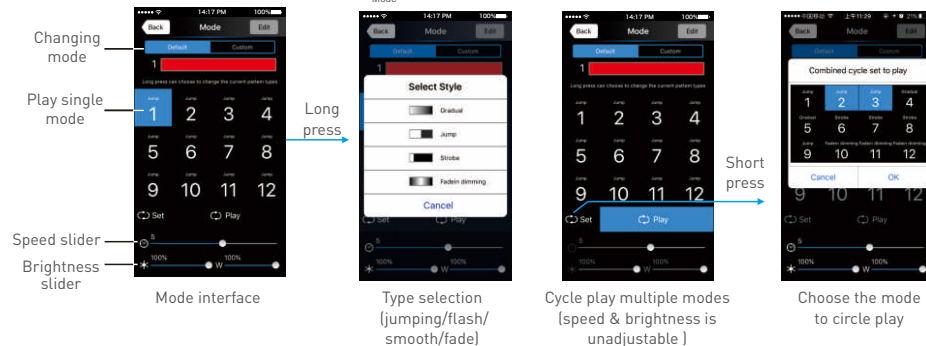

4.2.7 DIY Interface

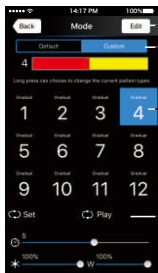

Edit DIY mode
 DIY mode
 Play single DIY mode
 Playback loop several DIY mode

DIY mode interface

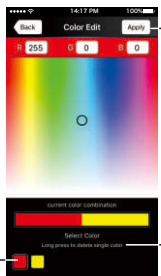

Save DIY
 Long press color box to delete current color
 Color box

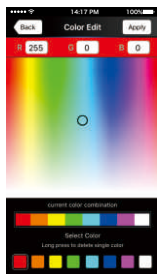

Edit single DIY mode

A. Group

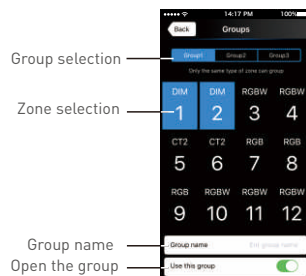

Group selection
 Zone selection
 Group name
 Open the group

Group interface



Group operations in main interface

4.2.8 More Function

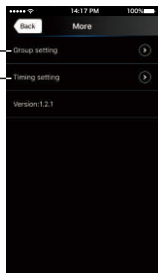

Group
 Timing

Group Features :

- Choose several zones as one group and control in sync.
- Max 3 groups, same LED types in one group and one zone could join multiple groups.
- Enable the group status, the corresponding group will appear on the main interface.
- Group settings will be auto off if zone LED type on & off state changed.

B. Timing

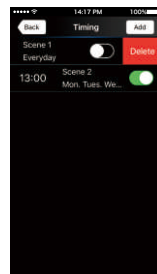

Slide left to delete timing

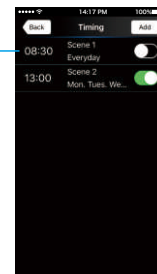

Timing interface

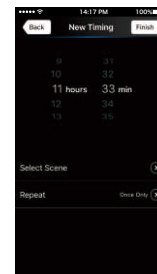

Add new timing

5. WiFi Network SSID Name and Password Setting

On device list interface, click "Network" key to enter Network interface, select "Change SSID and Password" (Click "⌕") to enter User Setting interface. Type new SSID name and password (Min. 8 characters, consist of 0-9, a-z and A-Z). Click "Apply" button on the top right corner of the interface to save the changes.

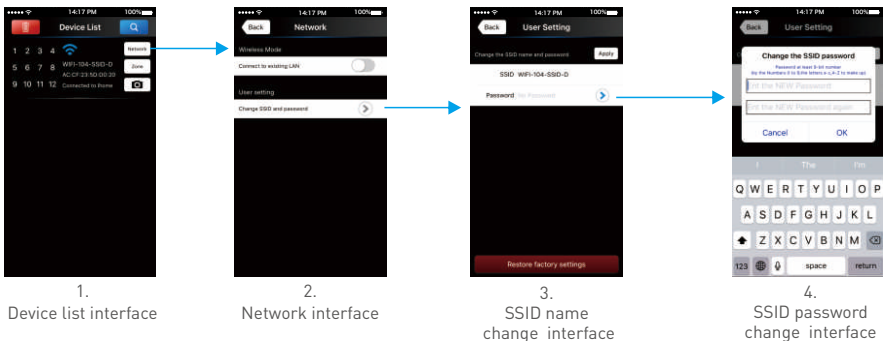

[Attn]: Direct connection of using WiFi-104 as a router, exit the App after the SSID name and the password changed, reconnect the WiFi-104 on the mobile devices.

For extra router connection, just press "🔍" on Device List interface to research WiFi-104.

[Attn]: If forget the WiFi network password, press "MATCH" and "SCENE" button simultaneously above 2s to restore the factory default settings and delete the WiFi network password (see P3) [Restore factory settings / Delete password]

6. Remote Operating Instructions

M12 Remote

Working Voltage:	3Vdc (CR2032 button battery)
Transmitting Frequency:	2.4GHz
Dimensions:	L106×W60×H9(mm)
Weight (G.W):	42g

Learning ID

Short press "MATCH" on WiFi-104, the buzzer long beep, press any key on M12, the buzzer beep again, ID matched.

Cancelling ID

Long press "MATCH" on WiFi-104 above 6s, the buzzer long beep, ID cancelled (cancelled all matched remotes).

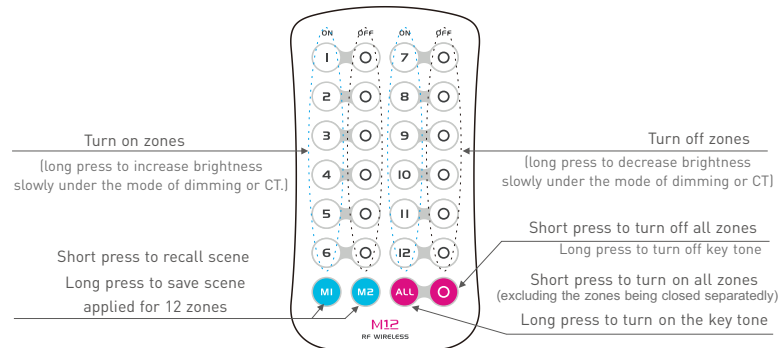

7. Wiring Diagram

7.1 Connection Between Zone Receiver to LEDs (Same as WiFi-104)

[Attn]: WiFi-104 itself is defaulted as zone NO.1, connecting lights is optional, slave control will be zone NO.1, if not connected.

All zones could be used for same LED types or not. e.g. single color dimming in all zones, all set to DIM type. Set different LED type in each zone accordingly (Dimming, CT or RGB, etc.).

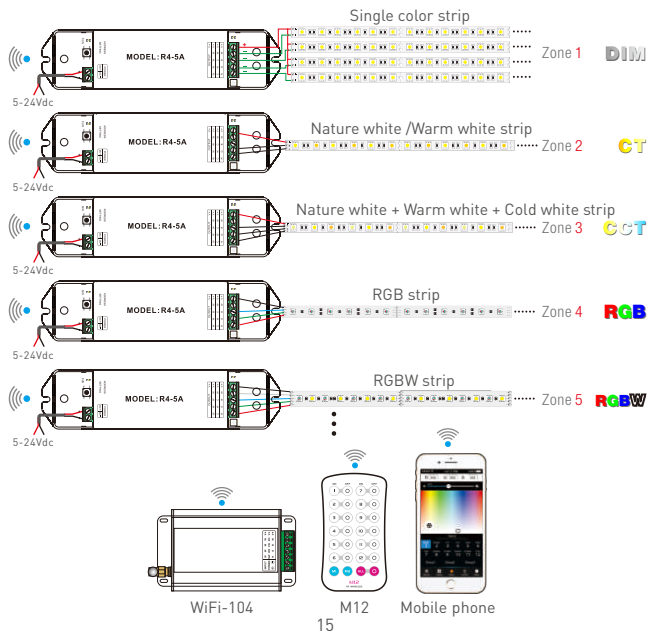

7.2 Direct Connection of Using WiFi-104 as Router

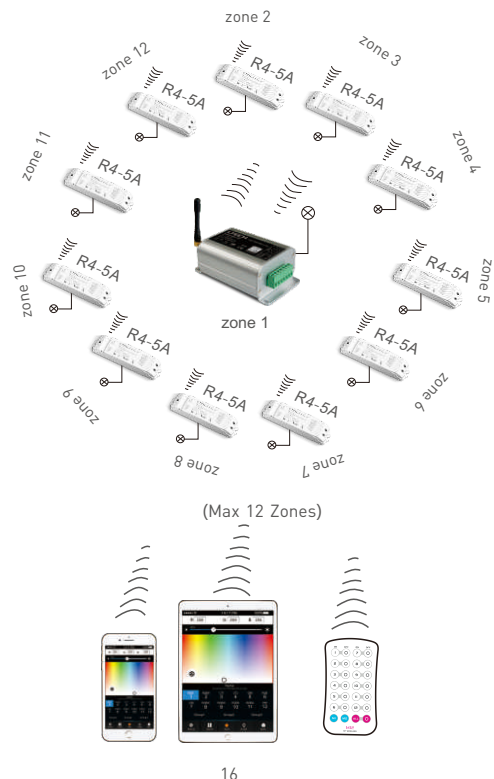

7.3 Extra Router Connection

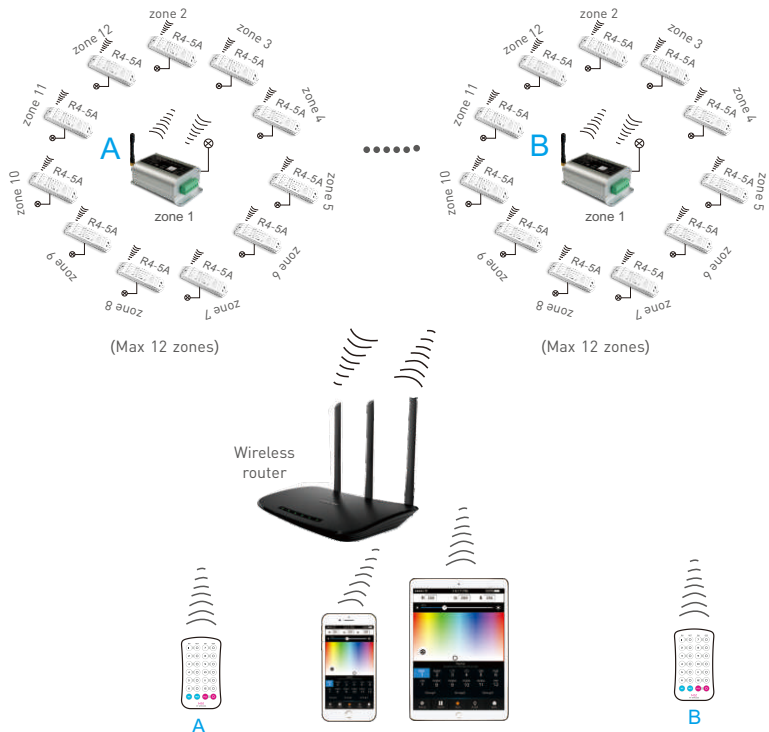

[Attn] unlimited zone receiver R4-5A/R4-CC can be installed for each zone within effective range.

7.4 Remote Distance Reference

[Attn]: The following distance figures is measured in spacious environment. Please refer to the actual test distance before installation.

