

LED Intelligent Driver (constant voltage)

- Small size and light weight. The housing is made from V0 flame retardant PC materials that SAMSUNG/COVESTRO uses.
- The clamshell design and screwless type for strain-relief. The design of dismountable end cap allows you to adjust the length of housing depending on your needs.
- Dimming interface: DMX512/RDM, Push DIM.
- Dimming range from 0-100%, LED start at 0.1% possible.
- With soft-on and fade in function, visual more comfortable.
- Supports RDM remote device management protocol.
- High efficient driver: efficiency 93%, PF>0.98, THD<6%.
- In line with the EU energy efficiency ERP directive, standby power consumption < 0.5W.
- Innovative thermal management technology, intelligent power life protection.
- Over-heat / Over voltage / Over load / Short circuit protection, recover automatically.
- Fully-protected plastic housing with design of dismountable end cover.
- Suitable for internal lights application for I / II / III.
- Up to 50,000-hour life time.
- 5 years warranty (Rubycon capacitor).



Flicker Free
IEEE 1789

Dimmable:
0.1%-100%

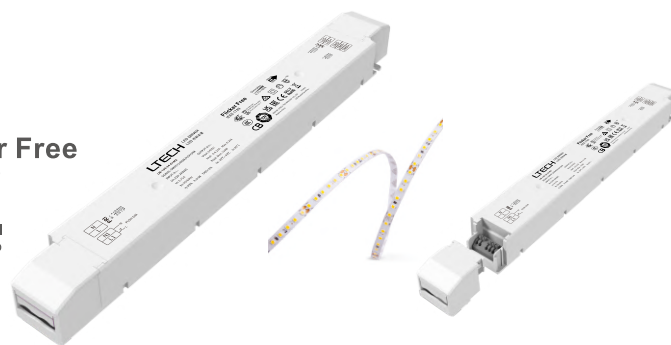

Technical Specs

Model	LM-150-24-G1M2	LM-150-12-G1M2		
OUTPUT	Output Voltage	24Vdc	12Vdc	
	Output Voltage Range	24Vdc ± 0.5Vdc	12Vdc ± 0.5Vdc	
	Output Current	Max. 6.25A	Max. 12.5A	
	Output Power	Max. 150W		
	Output Power Range	0~150W		
	Strobe Level	High frequency exemption level		
	Dimming Range	0~100%, down to 0.1%		
	Overload Power Limitation	≥102%		
	Ripple	Switch ripple≤200mV, noise≤500mV	Switch ripple≤200mV, noise≤800mV	
PWM frequency	3600Hz			
INPUT	Dimming Interface	DMX/RDM, Push DIM		
	Input Voltage	220-240Vac 200-280Vdc		
	Frequency	50/60Hz		
	Input Current	≤0.75A/230Vac		
	Power Factor	PF>0.98/230Vac [at full load]		
	THD	THD<6%@230Vac [at full load]		
	Efficiency (typ.)	93%	92%	
	Standby Power Loss	0.5W		
	Inrush Current	Cold start 45A/230Vac		
Anti Surge	L-N: 2KV			
Leakage Current	Max. 0.5mA			
ENVIRONMENT	Working Temperature	ta: -20 ~ 50°C tc: 85°C		
	Working Humidity	20 ~ 95%RH, non-condensing		
	Storage Temperature, Humidity	-40 ~ 80°C, 10~95%RH		
	Temperature Coefficient	±0.03%/°C [0-50°C]		
Vibration	10~500Hz, 2G 12min/1cycle, 72 min for X, Y and Z axes respectively			
PROTECTION	Overheat Protection	Intelligently adjust or turn off the output current if the PCB temperature ≥110°C, and recover automatically		
	Overload Protection	Shut down the output when current load≥102%, and recover automatically		
	Short Circuit Protection	Enter hiccup mode if short circuit occurs, and recover automatically		
	Overvoltage Protection	Shut down the output when non-load voltage≥28V, and recover automatically	Shut down the output when non-load voltage≥16V, and recover automatically	
SAFETY & EMC	Withstand Voltage	I/P-O/P: 3750Vac		
	Isolation Resistance	I/P-O/P: 100MQ/500VDC/25°C/70%RH		
	Safety Standards	CCC	China	GB19510.1, GB19510.14
		TUV	Germany	EN61347-1, EN61347-2-13, EN62493
		CB	CB member states	IEC61347-1, IEC61347-2-13
		CE	European Union	EN61347-1, EN61347-2-13, EN62384, EN61547
		KC	Korea	KC61347-1, KC61347-2-13
		EAC	Russia	IEC61347-1, IEC61347-2-13
		RCM	Australia	AS 61347-1, AS 61347-2-13
		EMEC	Europe	EN61347-1, EN61347-2-13, EN62384
	UKCA	Britain	BS EN 61347-2-13:2014+A1:2017, BS EN 61347-1:2015+A1:2021	
	EMC Emission	CCC	China	GB/T17743, GB17625.1
		CE	European Union	EN55015, EN61000-3-2, EN61000-3-3, EN61547
		KC	Korea	KN15, KN61547
		EAC	Russia	IEC62493, IEC61547, EH55015
RCM		Australia	EN55015, EN61000-3-2, EN61000-3-3, EN61547	
UKCA		Britain	BS EN IEC 55015:2019/A11:2020, BS EN 61547:2009, BS EN IEC 61000-3-2:2019, BS EN 61000-3-3:2013/A1:2019	
EMC Immunity	EN61000-4-2,3,4,5,6,8,11, EN61547			
Strobe Test Standard	IEEE 1789			
OTHERS	Gross weight[G.W]	430g±10g		
	Dimensions	352×43×30mm[L×W×H]		
	Package size	355×44×33mm[L×W×H]		
	Carton Size	370×340×93mm[L×W×H] 20pcs/ctn 9.4kg±5%/ctn		

The driver is suitable for connecting resistor current-limiting LED fixture (e.g. LED strip). The inrush current will be dozens of times increased if connecting built-in constant current IC current-limiting LED fixtures, the driver will activate the overloaded protection (hiccup flickering). When you order, please remark controlling the constant current LED fixture (e.g. MR16 lamp, underground light, LED wall washer, constant current LED strip, etc.), so that we can prepare them with special procedures.

Dimensions

Unit: mm



Wiring Diagram

DMX/RDM Connection

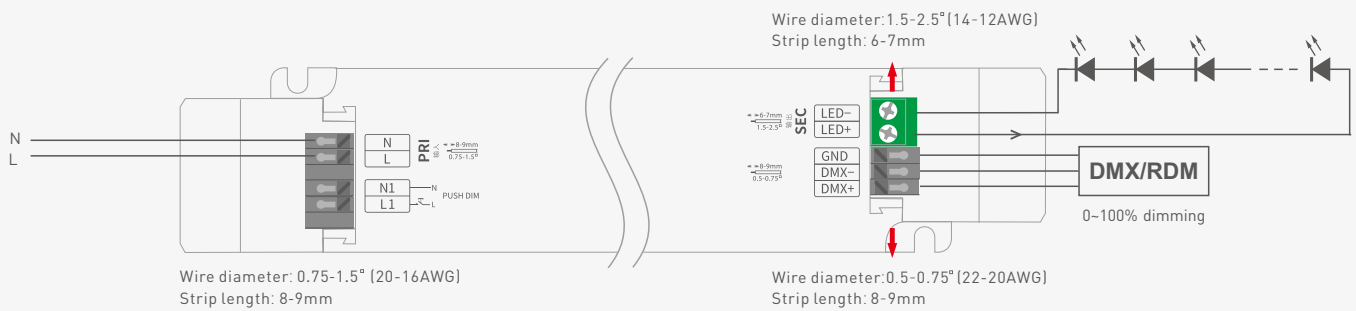

Push DIM Connection

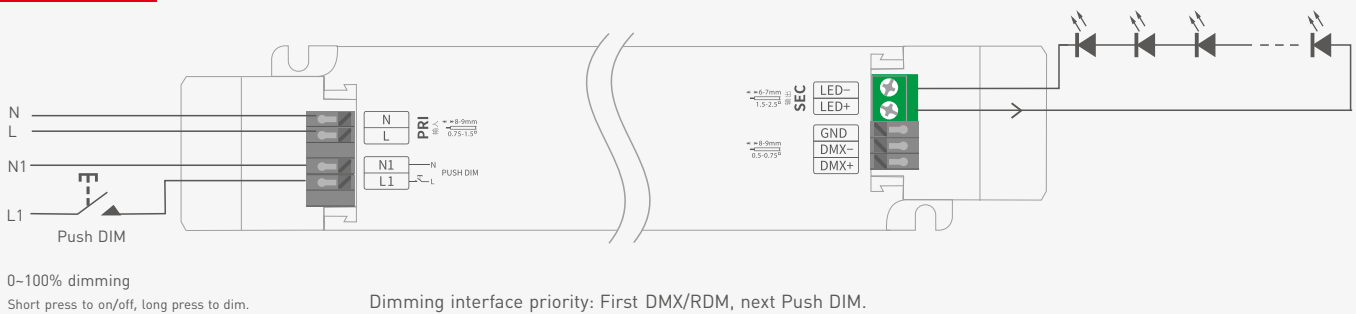

Push DIM



Reset switch

- On/off control: Short press.
- Stepless dimming: Long press.
- With every other long press, the brightness goes to the opposite direction.
- Dimming memory: Brightness will be the same as previously adjusted when turning on again.

Application of Protective Cover

Wire pressing board:

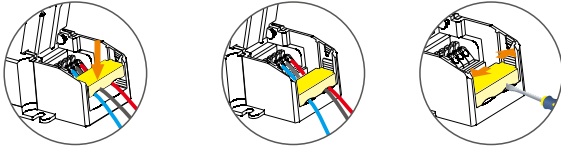

Push the wire pressing board to fix the wires.

Push outward the side plate, meanwhile use the tool to uninstall the wire pressing board.

Uninstall protective cover:

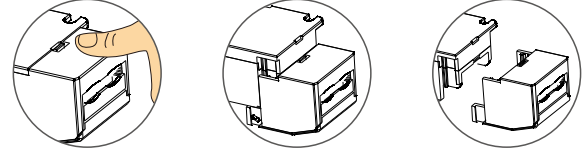

Break off the bottom left and right to remove the protective cover.

Installation Precautions

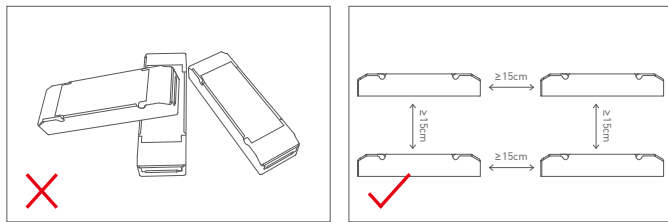

Please do not stack the products. The distance between two products should be $\geq 15\text{cm}$ so as not to affect heat dissipation and the lifespan of the products.

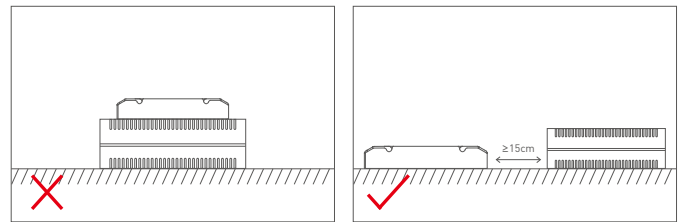

Please not place the products on LED drivers. The distance between the product and the driver should be $\geq 15\text{cm}$ so as not to affect heat dissipation and shorten the lifespan of the products.

DMX Address Setting

The DMX driver can work with the address editor that complies with standard RDM protocol.

It is recommended to use LTECH's RDM editor (model WiFi-RDM01), which can achieve more functions such as remote browsing and parameter setting. Wiring diagram as below:

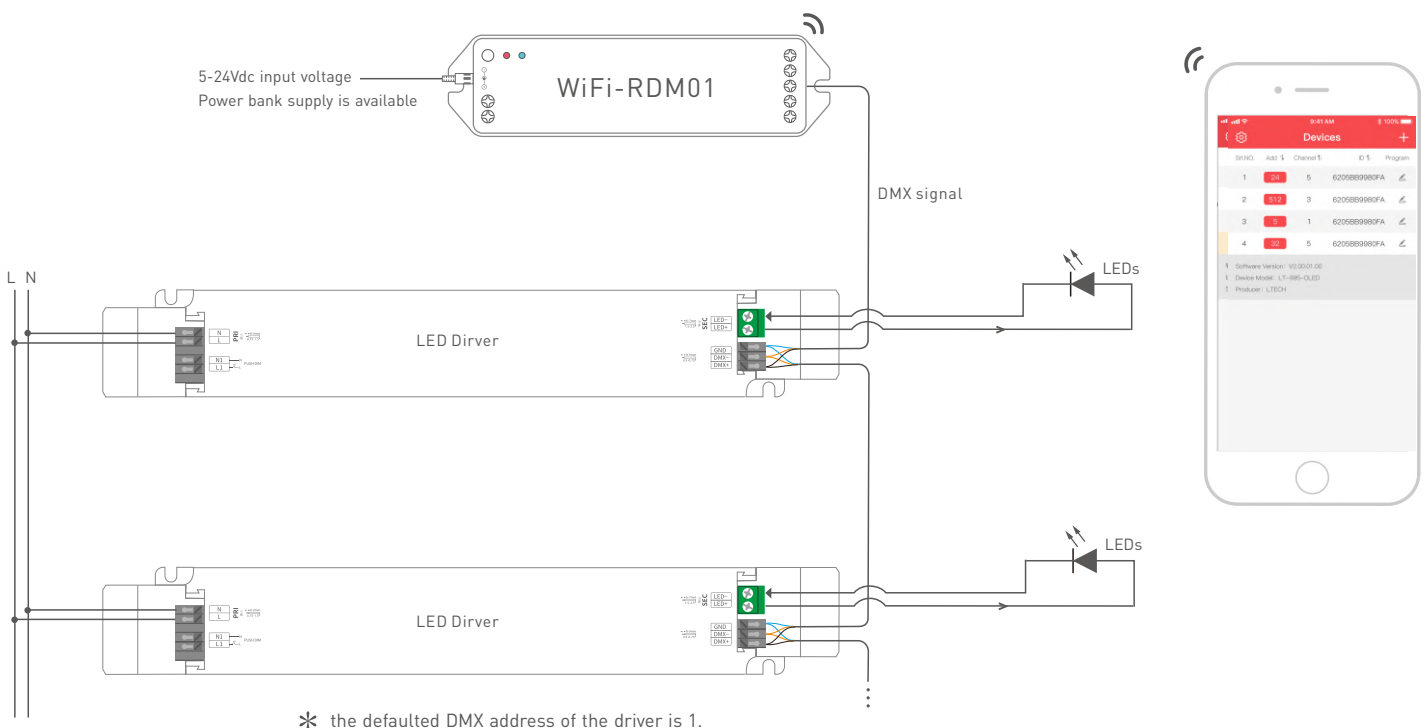

LTECH RDM editor App interface instruction

Download the App, setting the parameters after well connecting the RDM editor, please check the manual of WiFi-RDM01 for more details.

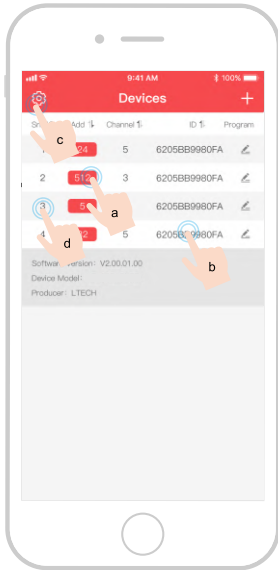

- a: Click "Add", edited the address in corresponding box.
- b: Click "ID", get more product details.
- c: Click "Settings", enter setting interface.
- d: Click "No.", issue the recognizing command.

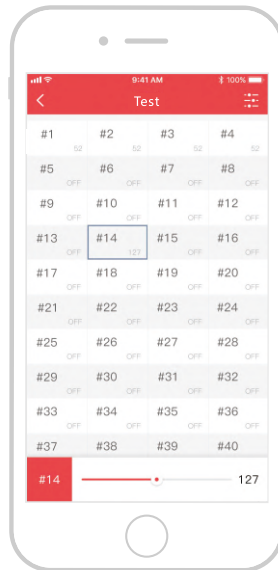

Test

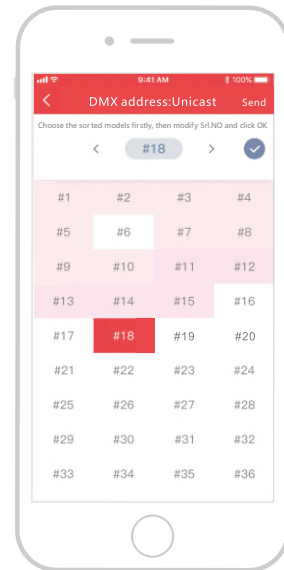

DMX address setting

Relationship Diagrams

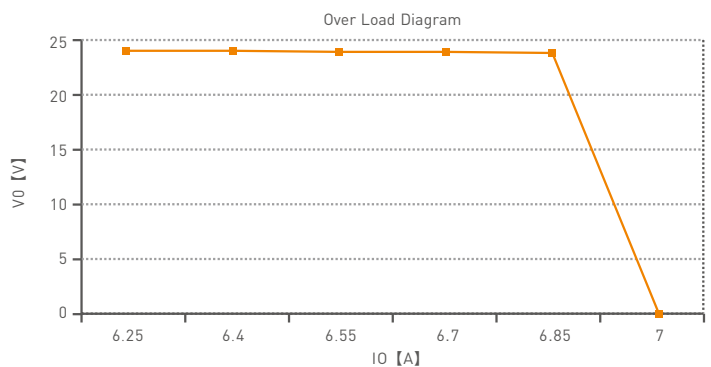
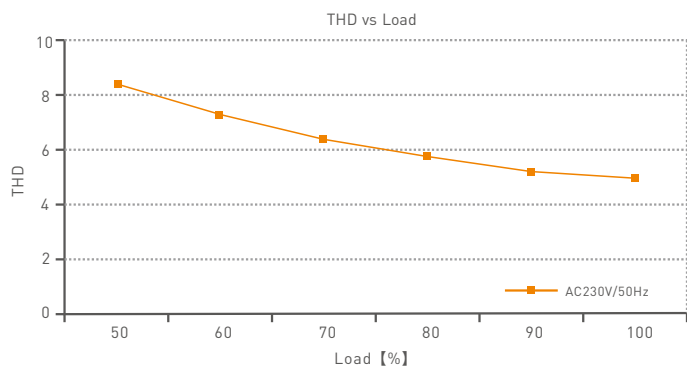
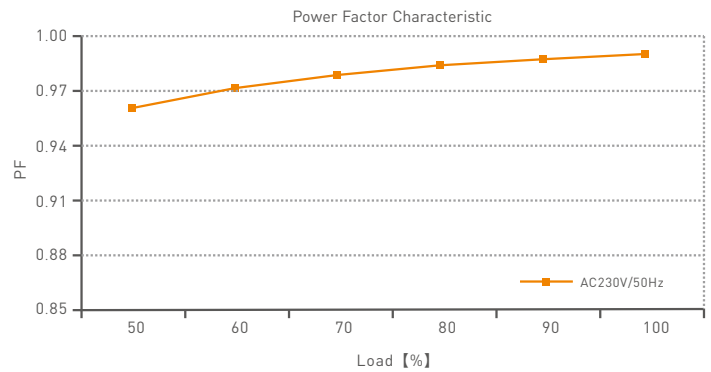
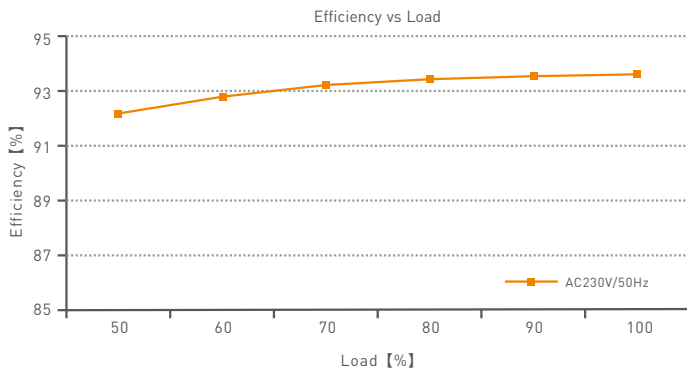

LM-150-24-G1M2

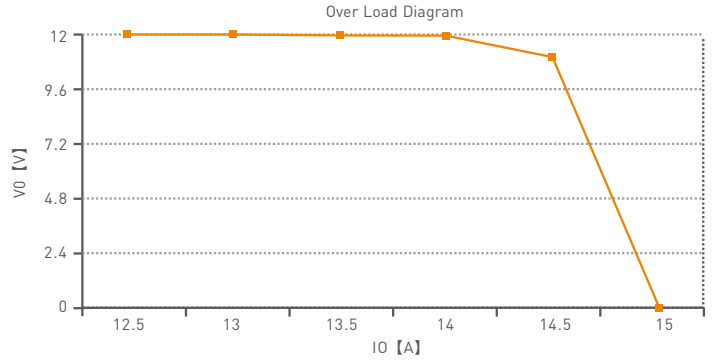
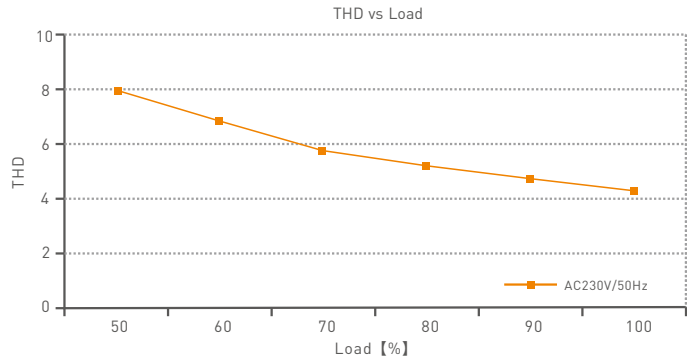
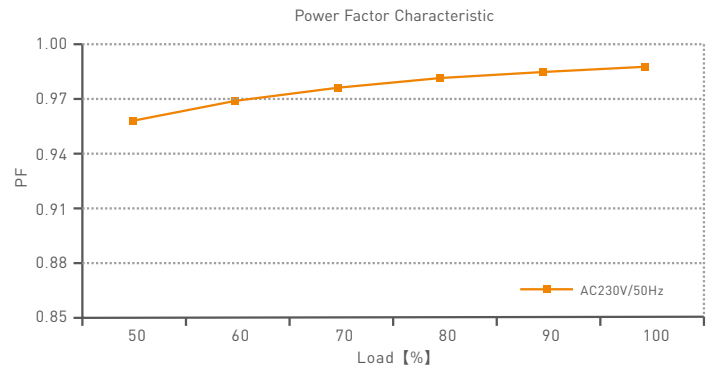
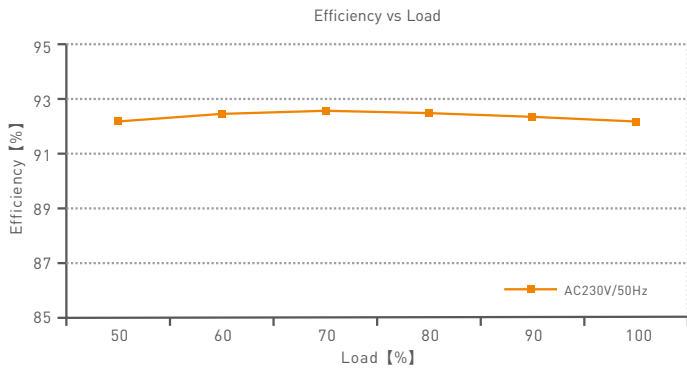

LM-150-12-G1M2

Flicker Test Form

IEEE 1789

Limit of Modulation in low risk area	
Waveform frequency of Optical output	limit (%)
$f \leq 8\text{Hz}$	0.2
$8\text{Hz} < f \leq 90\text{Hz}$	$0.025 \times f$
$90\text{Hz} < f \leq 1250\text{Hz}$	$0.08 \times f$
$f > 1250\text{Hz}$	Exemption assessment

Limit of Modulation in no effect area	
Waveform frequency of Optical output	limit (%)
$f \leq 10\text{Hz}$	0.1
$10\text{Hz} < f \leq 90\text{Hz}$	$0.01 \times f$
$90\text{Hz} < f \leq 3125\text{Hz}$	$(0.08/2.5) \times f$
$f > 3125\text{Hz}$	Exemption assessment (High frequency exemption)

Brightness

- ▲ 0.1 %
- ◆ 1 %
- ▲ 5 %
- ◆ 10 %
- 20 %
- ▲ 30 %
- 40 %
- ★ 50 %
- 60 %
- 70 %
- ◆ 80 %
- ★ 90 %
- ◆ 100 %

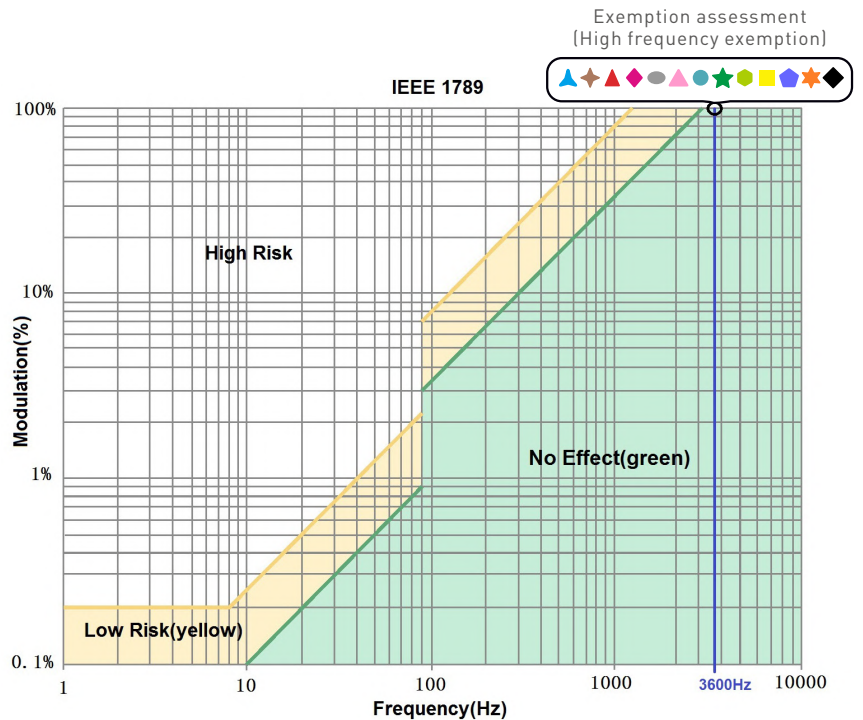

Attentions

- Products shall be installed by qualified professionals.
 - LTECH products are non-waterproof (special models excepted). Please avoid the sun and rain. When installed outdoors, please ensure it is mounted in a water proof enclosure.
 - Good heat dissipation will extend the working life of products. Please ensure good ventilation.
 - Please check if the working voltage used complies with the parameter requirements of products.
 - The diameter of wire used must be able to load the light fixtures you connect and ensure the firm wiring.
 - Before you power on products, please make sure all the wiring is correct in case of incorrect connection that causes damage to light fixtures.
 - If a fault occurs, please do not attempt to fix products by yourself. If you have any question, please contact your suppliers.
- * This manual is subject to changes without further notice. Product functions depend on the goods. Please feel free to contact our official distributors if you have any question.

Warranty Agreement

- Warranty periods from the date of delivery: 5 years.
- Free repair or replacement services for quality problems are provided within warranty periods.

Warranty exclusions below:

- Beyond warranty periods.
- Any artificial damage caused by high voltage, overload, or improper operations.
- Products with severe physical damage.
- Damage caused by natural disasters and force majeure.
- Warranty labels and barcodes have been damaged.
- No any contract signed by LTECH.

1. Repair or replacement provided is the only remedy for customers. LTECH is not liable for any incidental or consequential damage unless it is within the law.
2. LTECH has the right to amend or adjust the terms of this warranty, and release in written form shall prevail.

Update Log

Version	Updated Time	Update Content	Updated by
A0	2020.03.24	Original version	Huang Yunting
A1	2020.05.13	Update the relationship chart; increase the rated life of 50000 hours	Huang Yunting
A2	2021.12.10	Update product description; update TUV certification icon	Liu Weili